



**CLASSIQUE**<sup>®</sup>  
GLAZINGS & CLADDINGS  
FRAMELESS GLASSES

---

## GLASS PARTITION SYSTEMS

CLASSIC ALUMINIUM WORKS PVT. LTD.

## WHO ARE WE?

Team Classic welcomes you to a world of architectural elegance. Our world class products and solutions open the doors to innumerable possibilities in both interior as well as exterior spaces. We partner with the world's leading specialist manufacturers to bring you the best in architectural products, engineering and consultancy. Our devotional services have benefited residential, corporate and real estate property developers and individuals looking for best solutions.

As a fenestration solution provider (at Window Planet), we offer a wide specialized range of Engineered Aluminum Windows - Euro Groove Windows, System Windows, Imported Windows, Slimline/ Minimal Windows along with upvc Windows, unique and extraordinary Aluwood Windows. We also execute (at CLASSIC) contemporary range of Glasses & Frameless Doors & Windows, Imported Slimline Partitions & Euro Groove Partitions, Glazings, ACP Cladding, HPL Claddings, Spider Facades, High End Aluminum Wardrobe Systems (first time in India), Automatic Entry Systems and much more.

We believe in giving you the complete and right solution so as to aesthetically enhance your interior & exterior spaces. Apart from all this, we also provide consultation & design services (our products only) while executing our products in your space. Collaborating with architects from an early stage, we make sure to deliver optimum solutions in designing and ensure that the quality standards are met and purpose is achieved.





## WHAT'S INSIDE?

**01**

**COLOSSEUM COLLECTION**  
Fine Glaze Partitions  
25mm x 25mm & 40mm x 25 mm

**06**

**ACROPOLIS COLLECTION**  
Wide Double Glaze Partitions  
25mm x 100mm

**02**

**EIFFEL COLLECTION**  
Slim Glaze Partitions  
25mm x 45mm

**07**

**BIG BEN COLLECTION**  
Style Door  
42mm x 75mm

**03**

**LOUVRE COLLECTION**  
Side Glaze Partitions  
25mm x 53mm

**08**

**DUOMO COLLECTION**  
Sliding Door

**04**

**PANTHEON COLLECTION**  
Ultra Glaze Partitions  
25mm x 80mm

**09**

**STONEHENGE COLLECTION**  
Technical Panel  
100mm x 100mm

**05**

**SISTINE COLLECTION**  
Wide Glaze Partitions  
25mm x 100mm

**10**

Accessories  
Architectural Hardware

## COLOSSEUM COLLECTION

### FINE GLAZE PARTITIONS

Classic's 'Colosseum Fine Glaze Collection' modular aluminum single glaze partition system offers a seamless look and lays more emphasis on the glass, which is both recyclable and lightweight. It consists of a section of dimensions 25mm x 25mm and 40mm x 25mm accompanied with a clip on system for easy glass installation.

#### FEATURES

- Section Dimension: 25mm x 25mm and 40mm x 25mm
- Silver/ Any Colour Powder Coated Finishes are Available
- Glass Thickness Supported: 10mm and 12mm
- Single Glazing
- Acoustical Insulation: 32 dB
- Partition Height: Up to 3000mm
- Curved Profile Available



# GET THE LOOK



# TECHNICALITIES

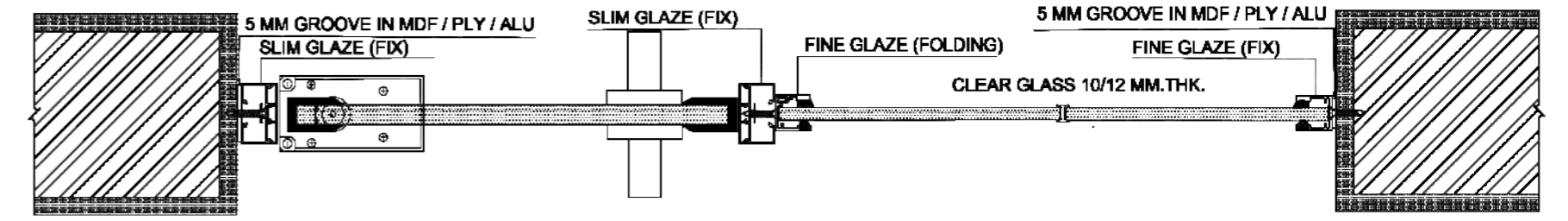
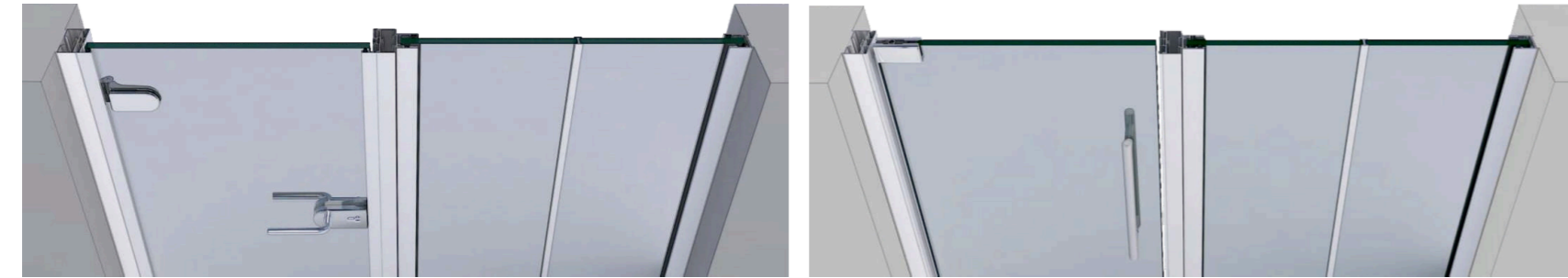
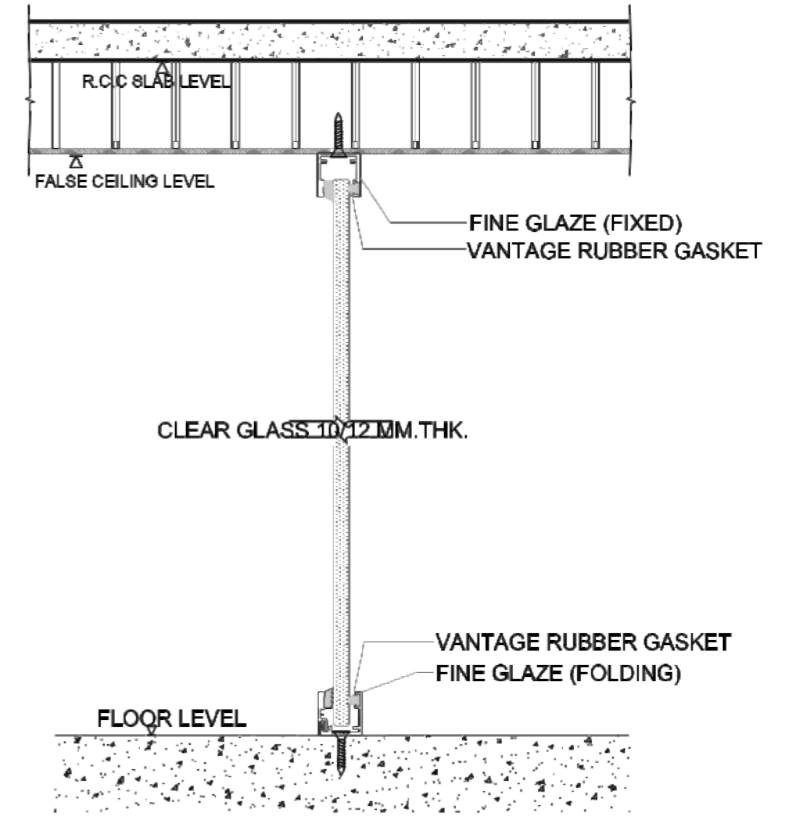
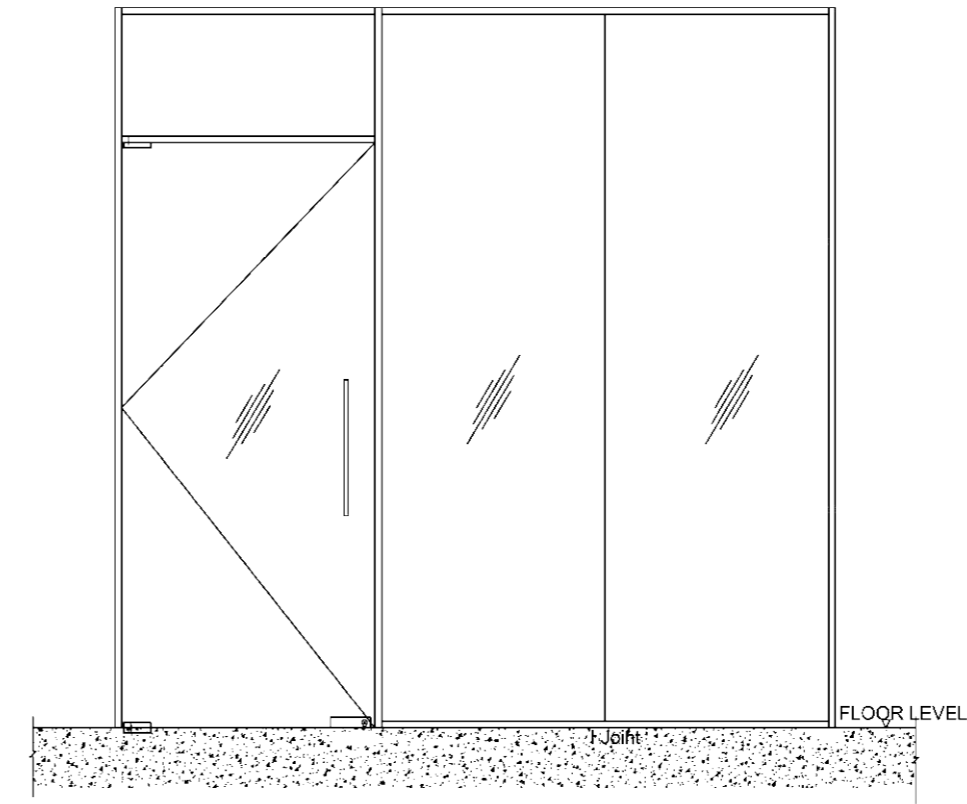

## EIFFEL COLLECTION

### SLIM GLAZE PARTITIONS

Classic's 'Eiffel Slim Glaze Collection' modular aluminum single glaze partition system offers a midway between a sleek and mechanically strong design while being cost effective. It consists of a section of dimensions 25mm x 45mm accompanied with a clip on system for easy glass installation.

#### FEATURES

- Section Dimension: 25mm x 45mm
- Silver/ Any Colour Powder Coated Finishes are Available
- Can be used for Door Frame with Cover or Rebate Profile
- Glass Thickness Supported: 10mm and 12mm
- Single Glazing
- Acoustical Insulation: 32 dB
- Partition Height: Up to 3000mm
- Curved Profile Available



# GET THE LOOK



# TECHNICALITIES

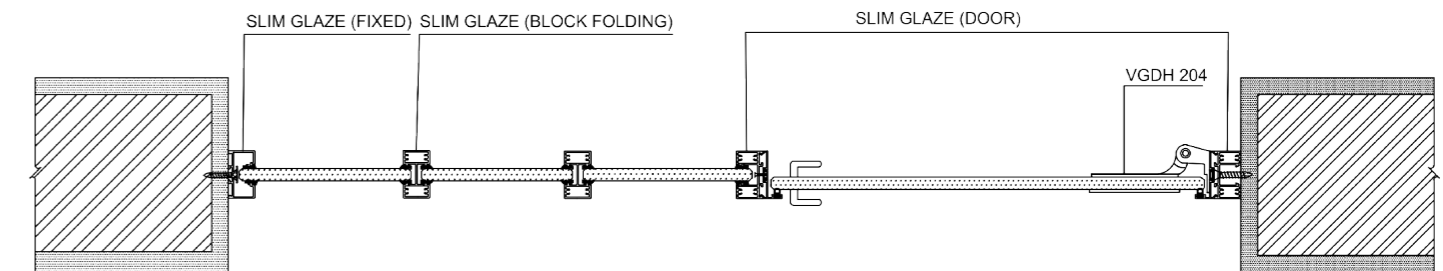
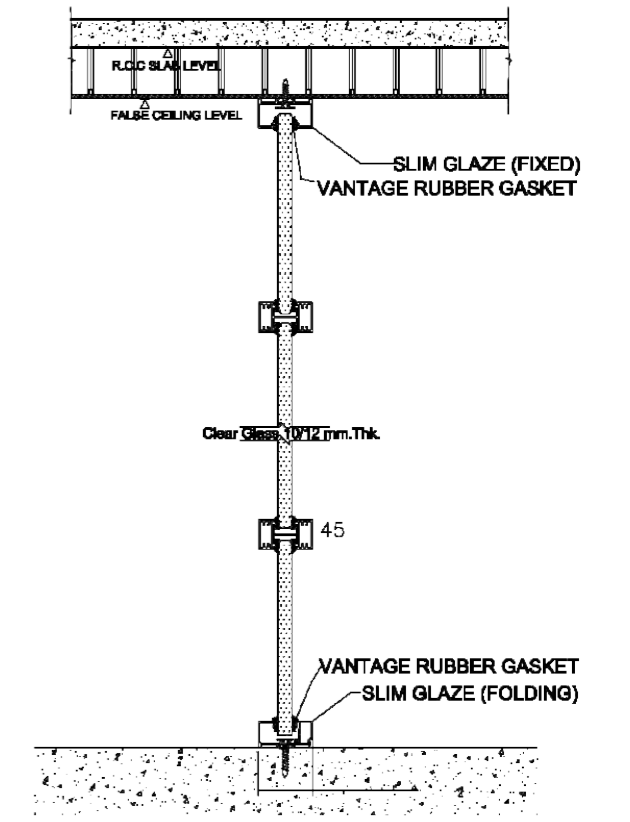
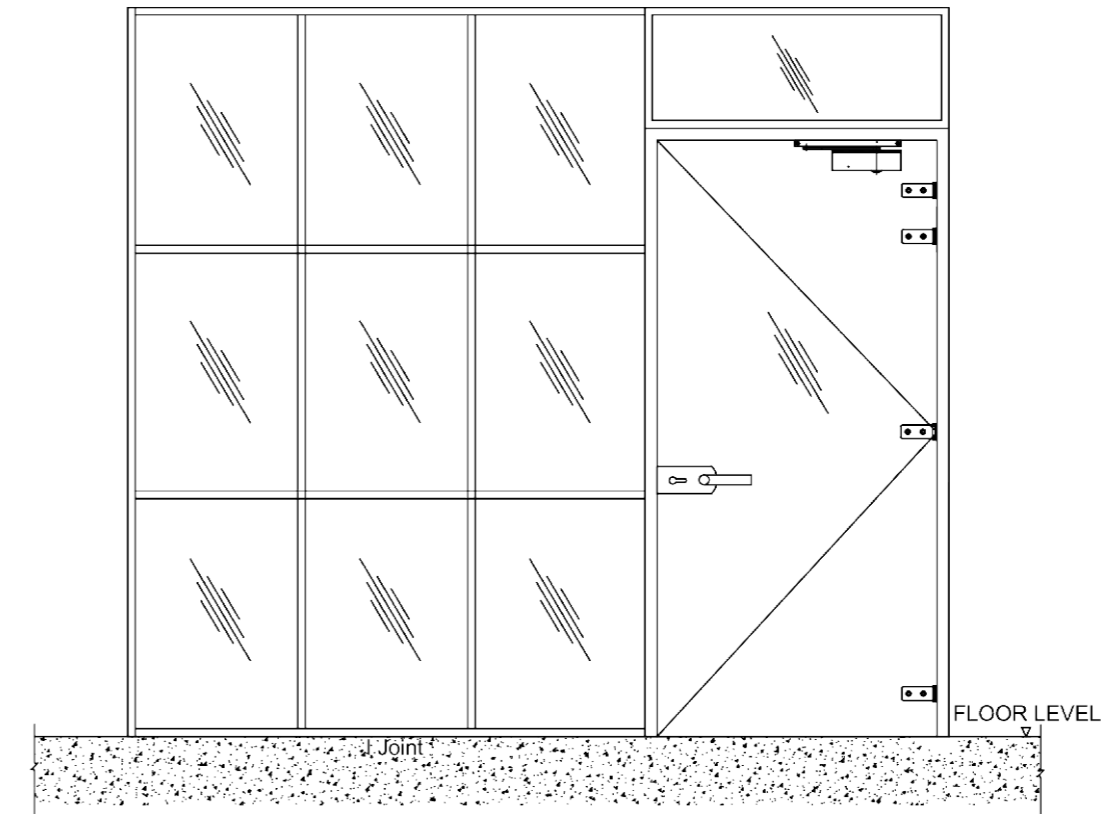

## LOUVRE COLLECTION

### SIDE GLAZE PARTITIONS

Classic's 'Louvre Side Glaze Collection' modular aluminum single glaze partition system is set apart from the rest as it is designed to place the partition glass at an offset from the center which gives a seamless look from outside the cabin while offering good strength due to its width. It consists of a section of dimensions 25mm x 53mm accompanied with a clip on system for easy glass installation.

#### FEATURES

- Section Dimension: 25mm x 53mm
- Silver/ Any Colour Powder Coated Finishes are Available
- Can be used for Door Frame with Cover or Rebate Profile
- Glass Thickness Supported: 10mm and 12mm
- Single Offset Glazing
- Acoustical Insulation: 32 dB
- Partition Height: Up to 3000mm





# GET THE LOOK



# TECHNICALITIES

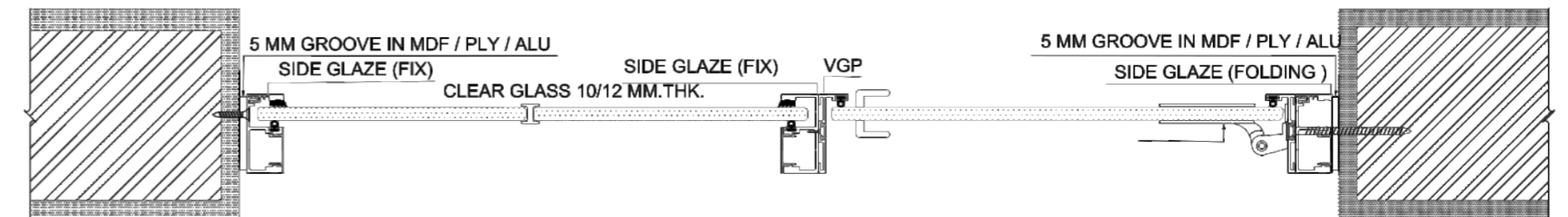
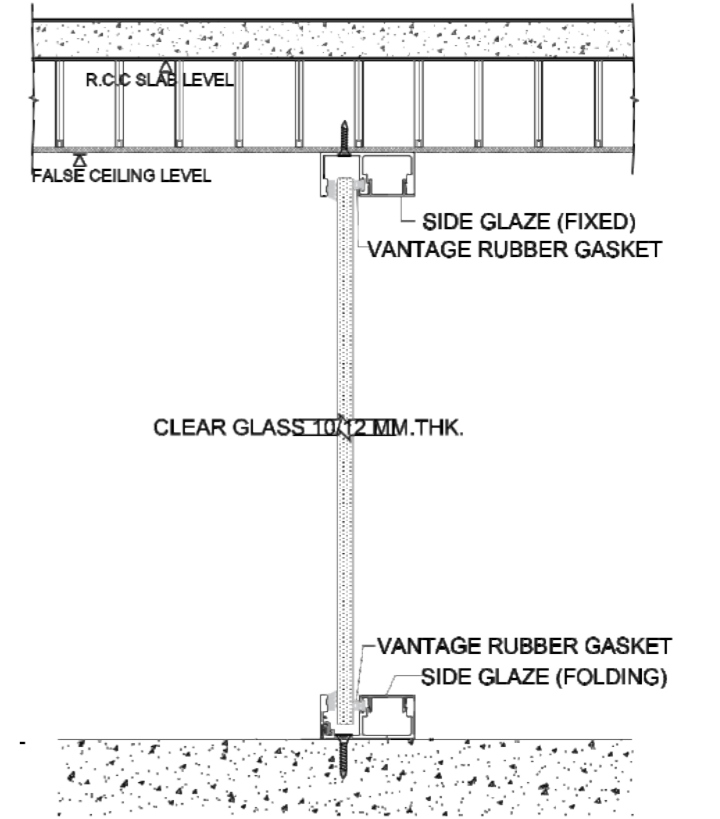
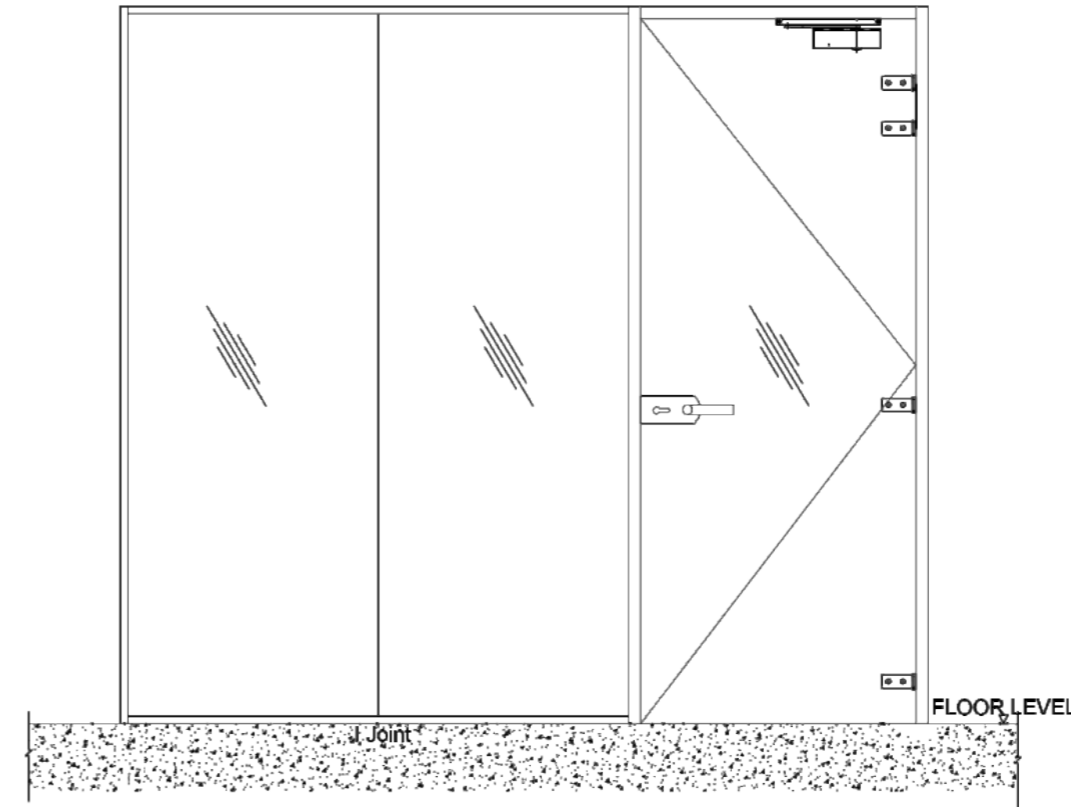

## PANTHEON COLLECTION

### ULTRA GLAZE PARTITIONS

Classic's 'Pantheon Ultra Glaze Collection' modular aluminum single glaze partition system is designed to nullify any undulations that occur in gypsum partitions which are of 75mm width as an industry standard and tend to never be straight edged which steals from the aesthetics of the partition system. Due to its heavy section dimension the system offers brilliant rigidity. It consists of a section of dimensions 25mm x 80mm accompanied with a clip on system for easy glass installation.

#### FEATURES

- Section Dimension: 25mm x 80mm
- Silver/ Any Colour Powder Coated Finishes are Available
- Can be used for Door Frame with Cover or Rebate Profile
- Glass Thickness Supported: 10mm and 12mm
- Single Glazing
- Acoustical Insulation: 32 dB
- Partition Height: Up to 3000mm



# GET THE LOOK



# TECHNICALITIES

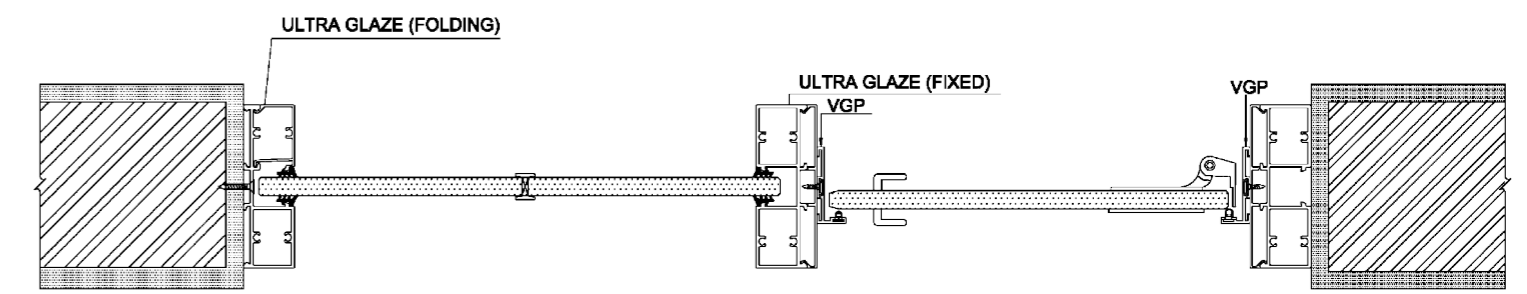
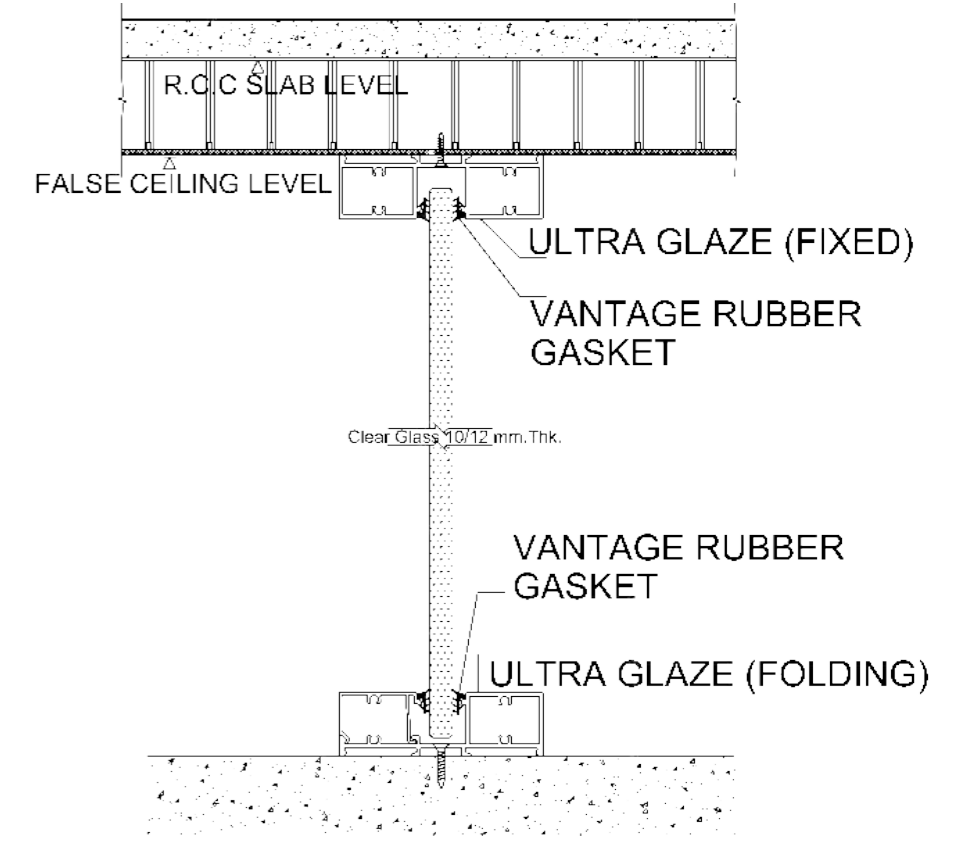
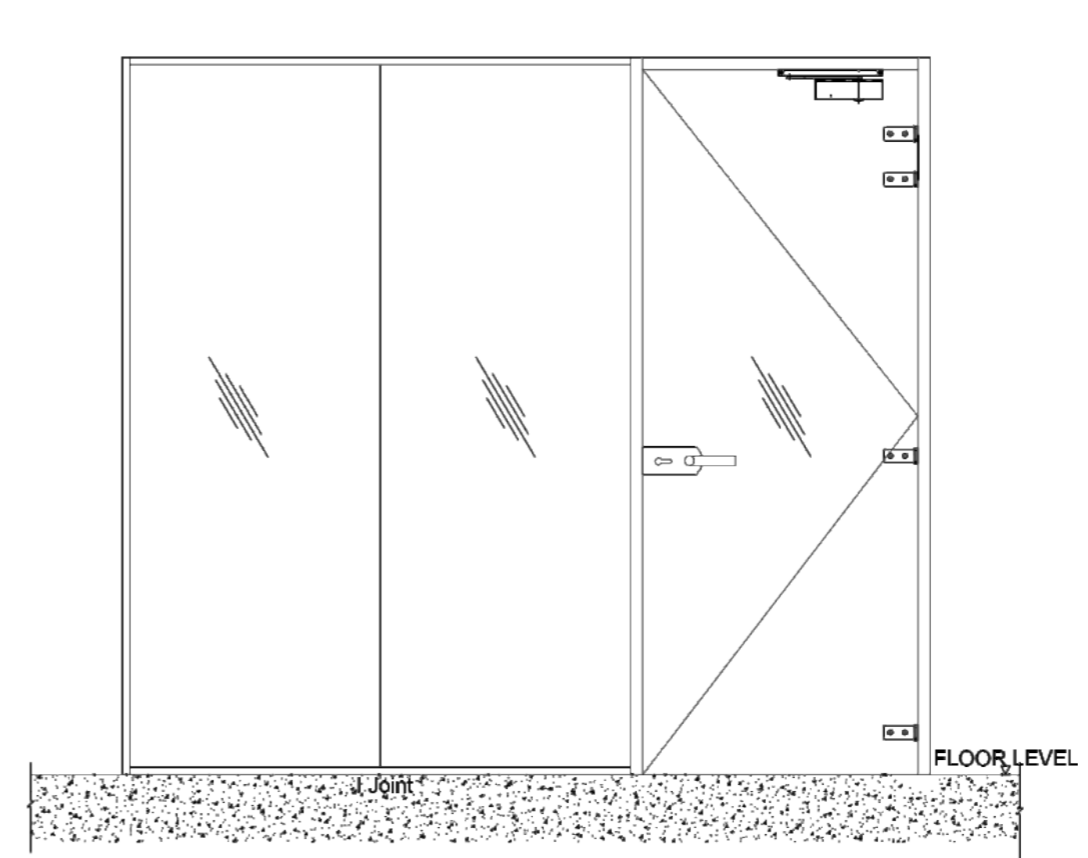

## SISTINE COLLECTION

### WIDE GLAZE PARTITIONS

Classic's 'Sistine Wide Glaze Collection' modular aluminum single glaze partition system offers the best rigidity and strength due to its heavy profile. It is also aesthetically pleasing due to its Glass to Section Dimension ratio. It consists of a section of dimensions 25mm x 100mm accompanied with a clip on system for easy glass installation.

#### FEATURES

- Section Dimension: 25mm x 100mm
- Silver/ Any Colour Powder Coated Finishes are Available
- Can be used for Door Frame with Cover or Rebate Profile
- Glass Thickness Supported: 10mm and 12mm
- Single Glazing
- Acoustical Insulation: 32 dB
- Partition Height: Up to 3000mm
- Curved Profile Available.



# GET THE LOOK



# TECHNICALITIES

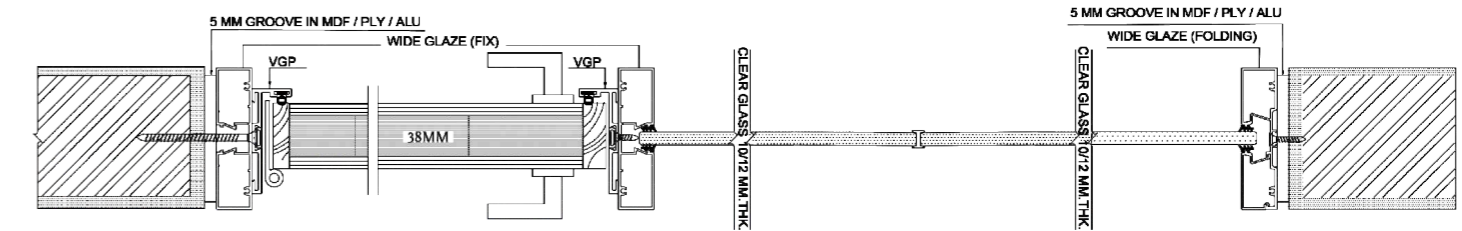
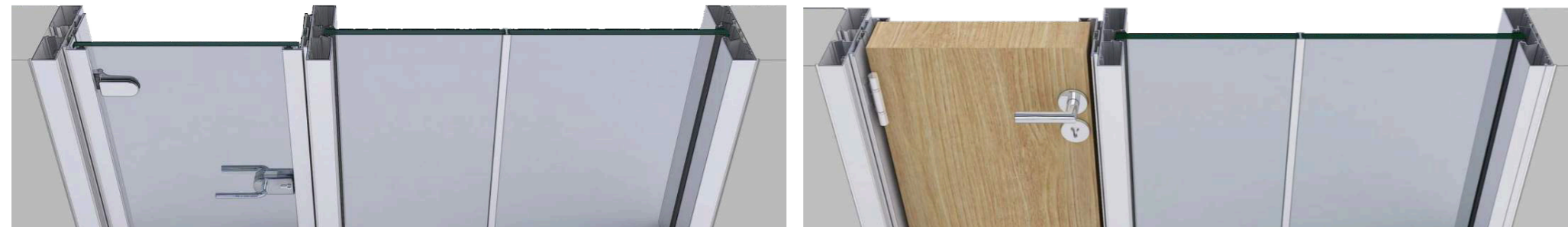
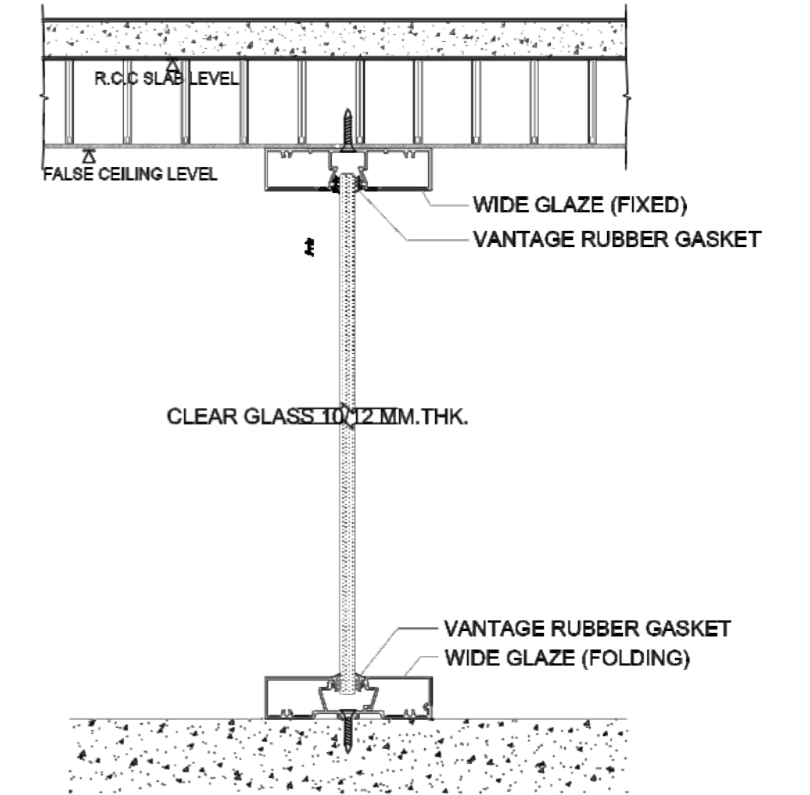
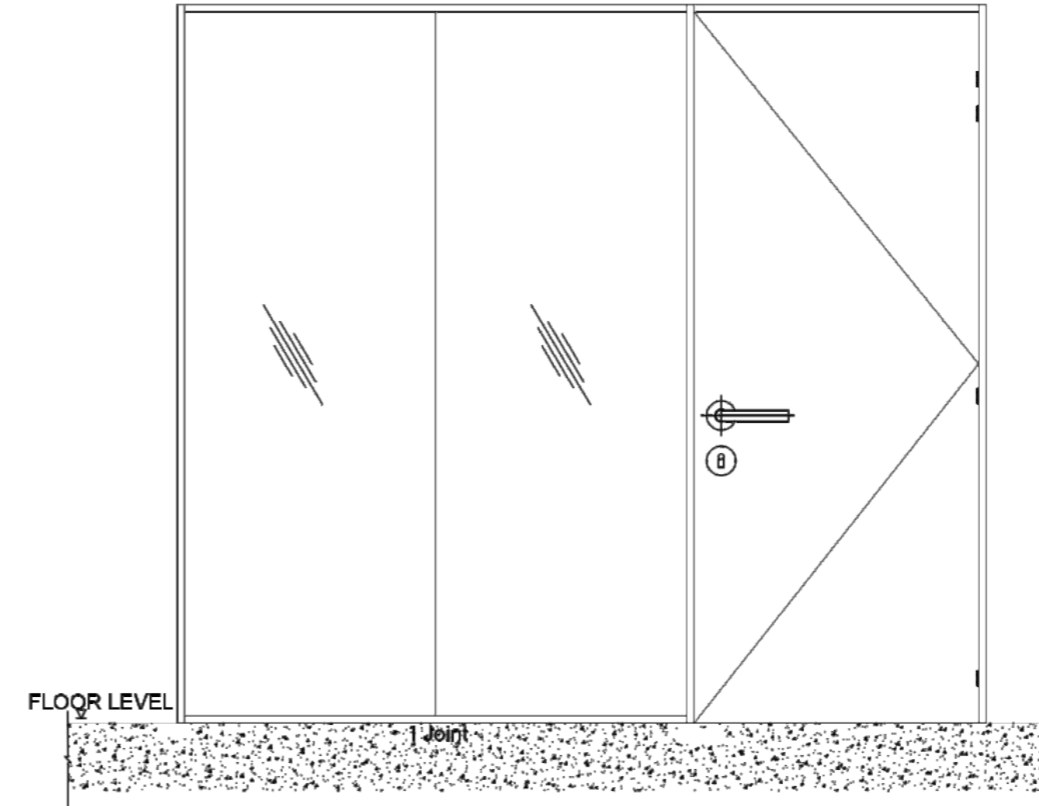

## ACROPOLIS COLLECTION

### WIDE DOUBLE GLAZE PARTITIONS

Classic's 'Acropolis Wide Double Glaze Collection' modular aluminum double glaze partition system offers high strength and rigidity. However, its main purpose is to provide the best sound insulation by adding an extra layer of glass and also an air gap between the two glass layers. It consists of a section of dimensions 25mm x 100mm accompanied with a clip on system for easy glass installation.

#### FEATURES

- Section Dimension: 25mm x 100mm (Dual Track)
- Silver/ Any Colour Powder Coated Finishes are Available
- Can be used for Door Frame with Cover or Rebate Profile
- Glass Thickness Supported: 10mm and 12mm
- Double Glazing
- Acoustical Insulation: 40 dB
- Partition Height: Up to 2700mm



GET THE LOOK

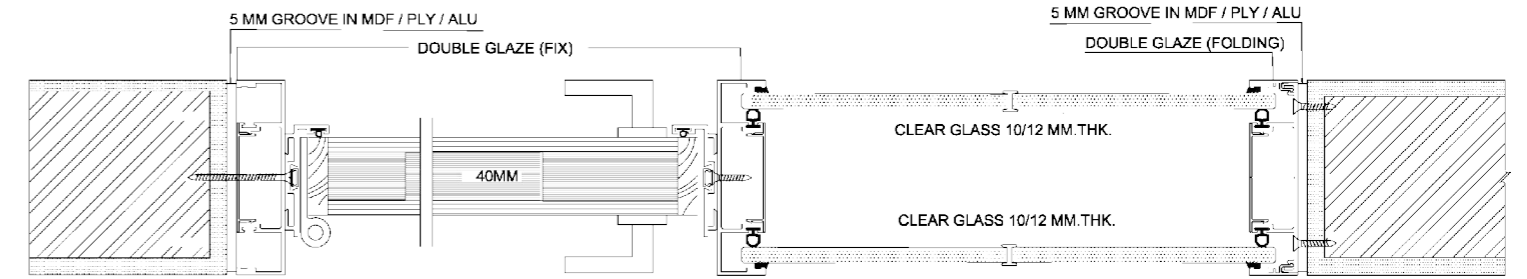
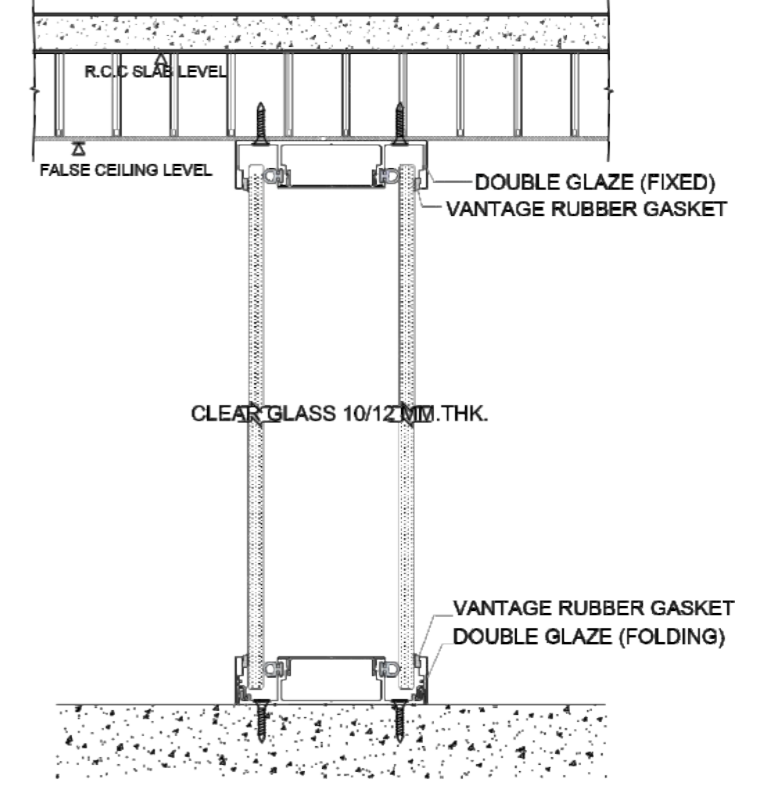
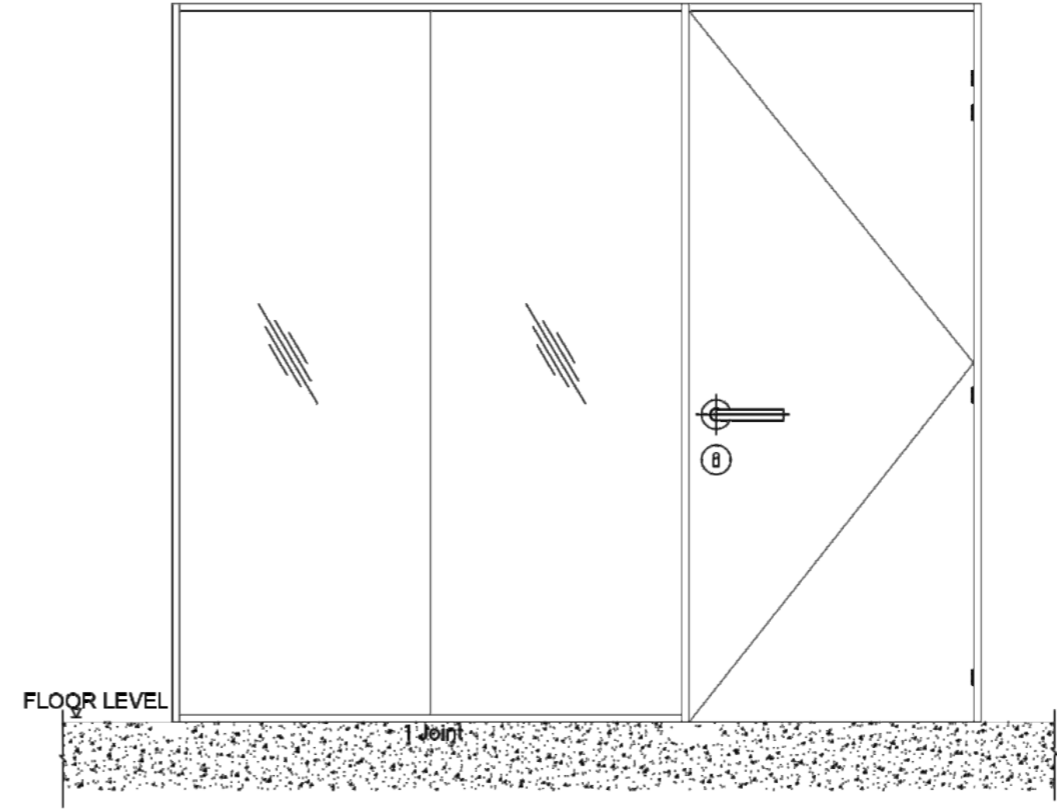

## BIG BEN COLLECTION

### STYLE DOOR

Classic's 'Big Ben Style Door Collection' is the new alternative to the aging solid wooden door with similar sound insulation abilities but at a relatively better price. It can be used as a swing door as well as a sliding door. It consists of a 42mm x 75mm section dimension to be used as a four sided frame with a layer of glass within the frame.

#### FEATURES

- Section Dimension: 42mm x 75mm
- Silver/ Any Colour Powder Coated Finishes are Available
- Single Glazed Door
- Glass Thickness Supported: 10mm
- Acoustical Insulation: 30 dB
- Maximum Single Leaf Dimensions: 2500mm (H) X 1000mm (W)





# GET THE LOOK



# TECHNICALITIES

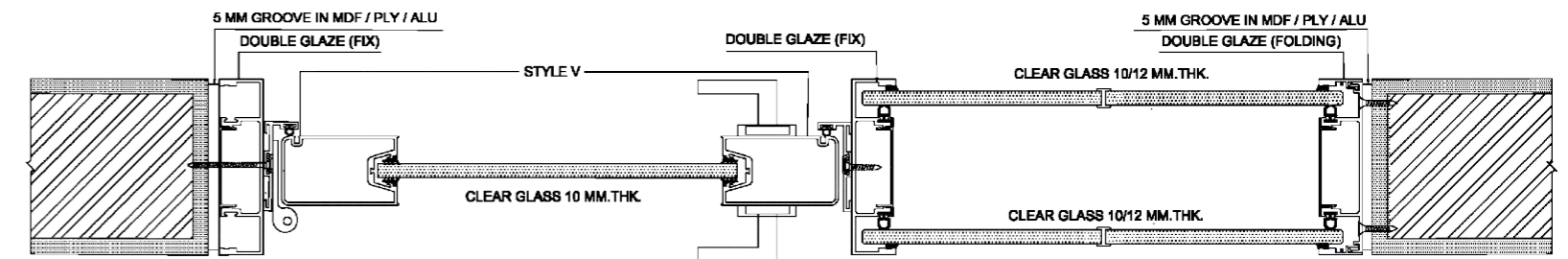
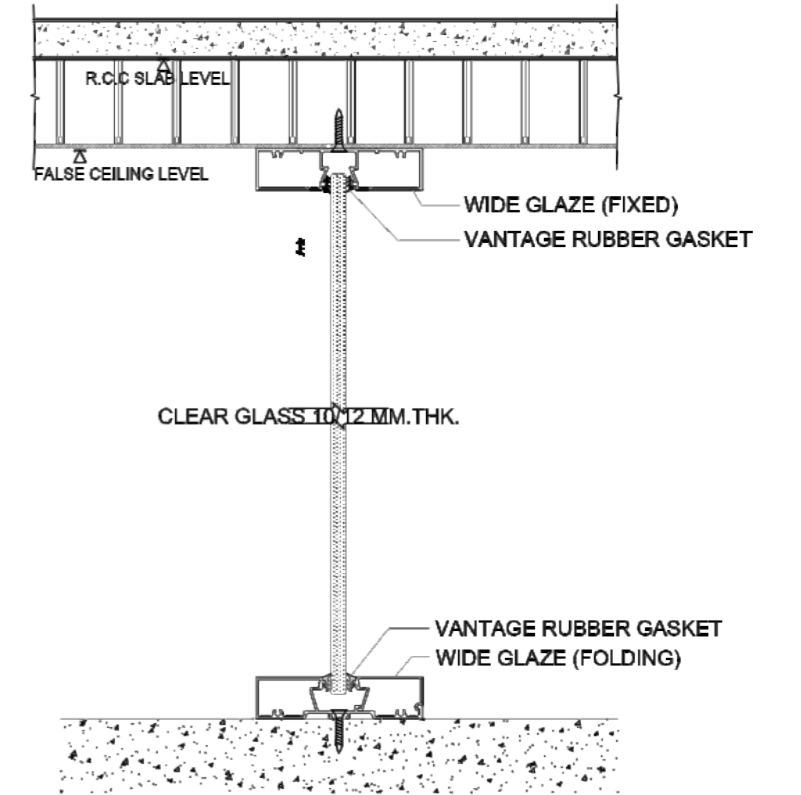
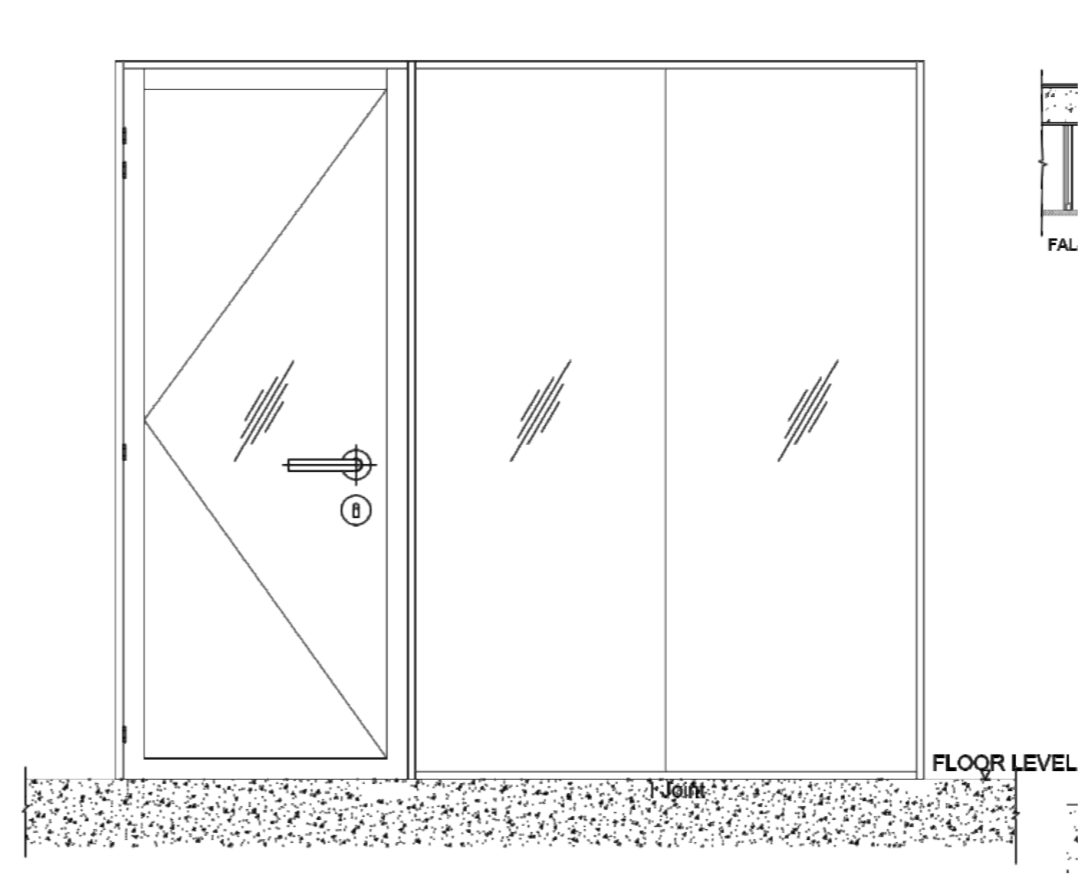

## DUOMO COLLECTION

### SLIDING DOOR

Classic's 'Duomo Sliding Door Collection' offers single/ double leaf, style/ frameless glass sliding doors with all necessary rollers, guides and sliding track. We have multiple designs of sliding tracks for various applications.

#### FEATURES

- Frameless and Style Shutter Options Available
- Silver/ Any Colour Powder Coated Finishes are Available
- Sleek Look and Smooth Functioning
- Glass Thickness Supported: 10mm and 12mm
- Maximum Single Leaf Dimensions: 2700mm (H) X 1000mm (W)



# GET THE LOOK

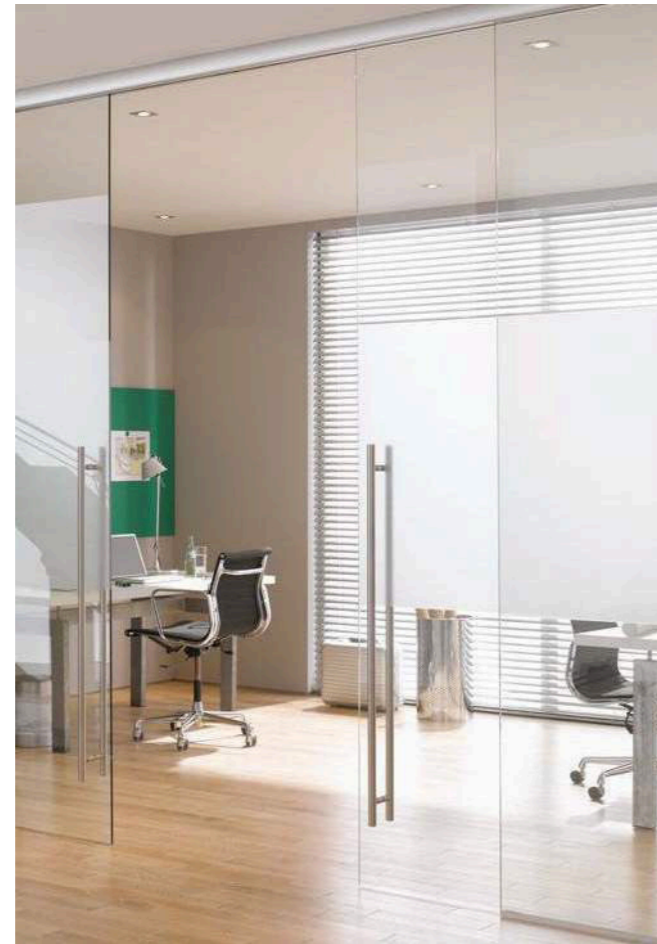

# TECHNICALITIES

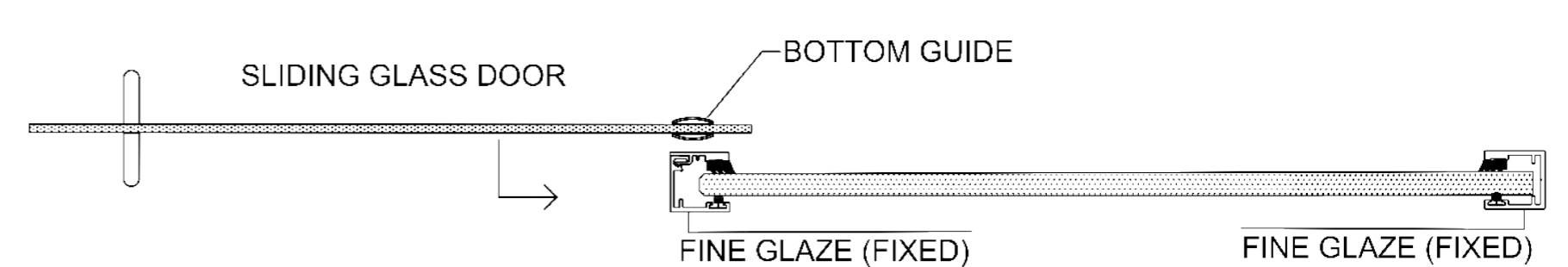
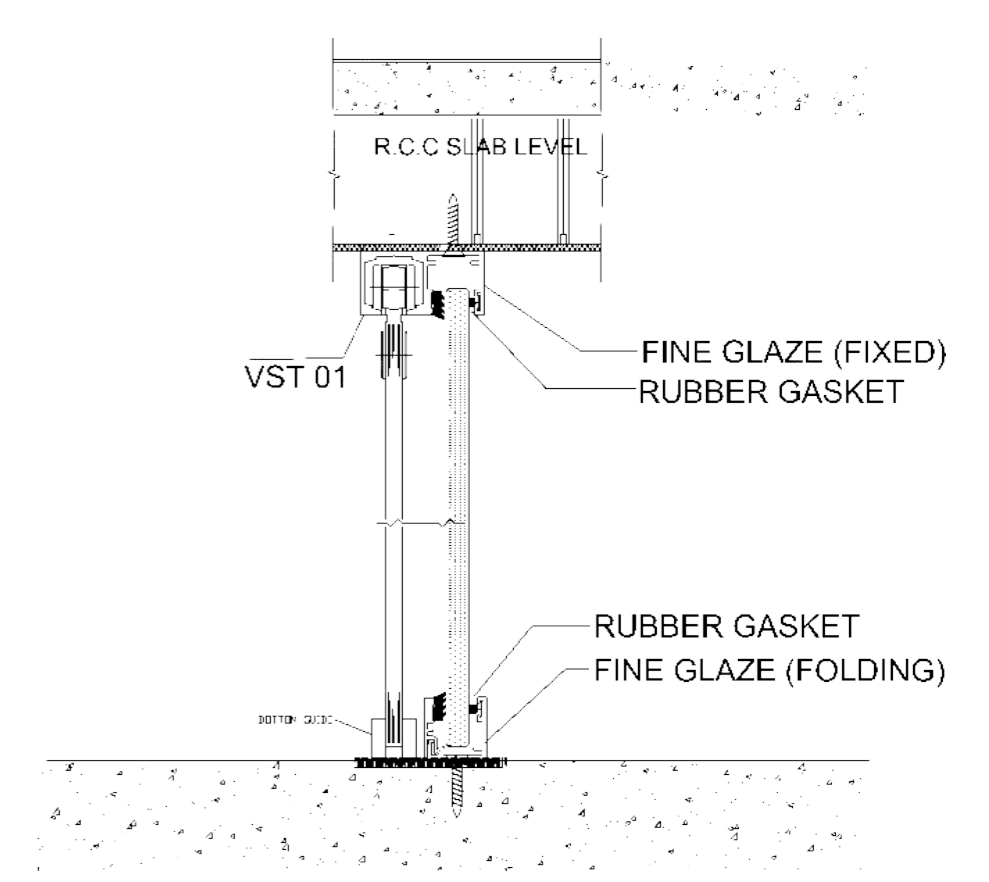
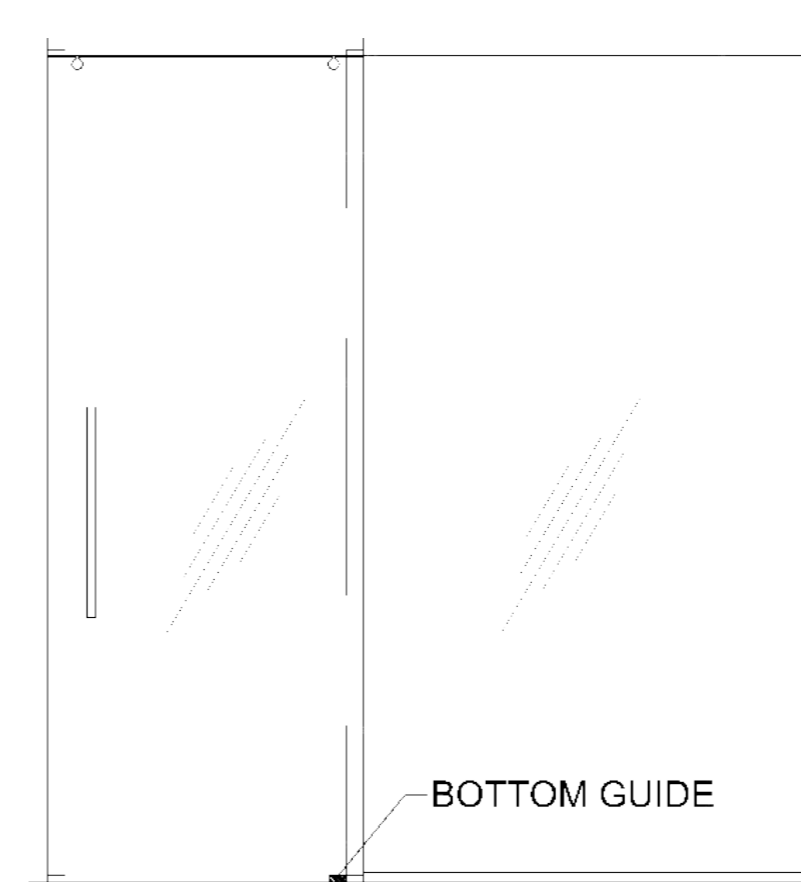

## STONEHENGE COLLECTION

### TECHNICAL PANEL

Classic's 'Stonehenge Technical Panel' is used as a more aesthetic and cost effective alternate to traditional wooden and gypsum section. It is also used as an access control panel.

#### FEATURES

- Section Dimension: 100mm x 100mm
- Silver/ Any Colour Powder Coated Finishes are Available
- Partition Height: Up to 3000mm

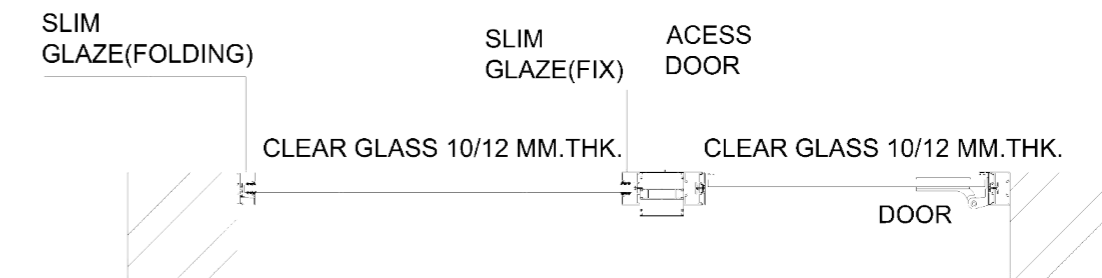

# ACCESSORIES

**Aluminum Skirting**

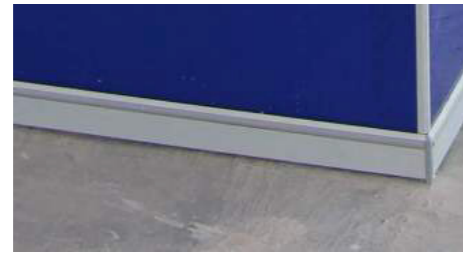

Height: 50mm/ 75mm/ 100mm  
 Length: 3000mm  
 Finish: Silver/ Anodized Colour Options

**CSP - 50/ 75/ 100mm**

**End Cap**



Can be used with all types of corner  
 Height: 100mm  
 Finish: Silver/ Anodized Colour Options

**CSP - END-50/ 75/ 100mm**

**Aluminum I Profile**



Suitable for joining 2 glasses (180°)  
 Transparent Tape to be used on profile for fixing glasses  
 Length: 3000mm  
 Finish: Silver/ Anodized Colour Options

**CGP - I-10/ 12mm**

**Clear L Profile**



Suitable for L joining at a common point  
 3M Tape to be used on profile for fixing glasses  
 Length: 3000mm  
 Finish: Transparent

**C - L-10/ 12mm**

**Clear T Profile**



Suitable for joining 3 meeting at a common point  
 3M Tape to be used on profile for fixing glasses  
 Length: 3000mm  
 Finish: Transparent

**C - T-10/ 12mm**

**Clear I Profile**



Suitable for joining 2 glasses (180°)  
 3M Tape to be used on profile for fixing glasses  
 Length: 3000mm  
 Finish: Transparent

**C - I-10/ 12mm**

**Aluminum T Profile**

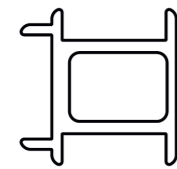

Suitable for joining 3 glasses meeting at a common point  
 Transparent Tape to be used on profile for fixing glasses  
 Length: 3000mm  
 Finish: Silver/ Anodized Colour Options

**CGP - T-10/ 12mm**

**Aluminum L Profile**

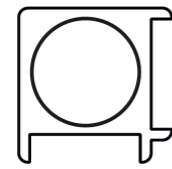

Suitable for L joining at a common point (90°)  
 Transparent Tape to be used on profile for fixing glasses  
 Length: 3000mm  
 Finish: Silver/ Anodized Colour Options

**CGP - L-10/ 12mm**

**Aluminum Hat Profile**



Hat Aluminum profile are developed to make wall design visually attractive, ideal for junction of 2 different materials  
 Length: 3000mm  
 Width: 5mm/ 8mm/ 10mm  
 Finish: Silver/ Anodized Colour Options

**CGP - HAT-5/ 8/ 10mm**

**Aluminum Stair Nose**



Stair Nose is made for all types of staircases to prevent slipping & skirting.  
 Size: 50mm x 18mm  
 Length: 2700mm  
 Finish: Silver/ Anodized Colour Options

**CGP - SN-01**

**Aluminum Carpet Profile**

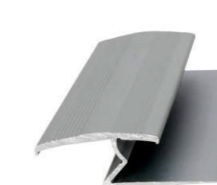

Variable double sided profile which bends as per the height of flooring on either side  
 Width: 28mm  
 Length: 3000mm  
 Finish: Silver/ Anodized Colour Options

**CGP - CP-02**

**Aluminum L Corner**

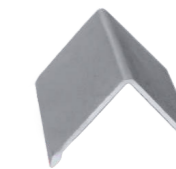

Provides protection to edge of wall corner  
 Economical option for edge of wall corners protection  
 Length: 3000mm  
 Width: 12 x 12mm/ 19 x 19mm/ 25 x 25mm  
 Finish: Silver/ Anodized Colour Options

**CGP - CG-12/ 19/ 25**

S.S. Flush Hinges



Size: 5 x 3 x 3  
Material: SS 304  
Type: Ball Bearing

CFH - 5BB

Studio Glass Door Lock



Suitable for 10mm/ 12mm Glass  
Finish: Silver Anodized  
Material: Aluminum

CPSL - 101

Glass Door Hinges



Door Weight Max. 30Kgs Per Pcs  
Suitable for 10mm/ 12mm Glass  
Finish: Silver Anodized  
Material: Aluminum

CPDH - 204

Glass Pivot Hinges



Easy Installation Height &  
Horizontal setting  
Door Weight Max. 80Kgs Per Set  
Suitable for 10mm/ 12mm Glass  
Finish: Silver Anodized  
Material: Aluminum

CPDH - 105

Saddle Plate



Plate for mounting door closer  
on glass  
Finish: Silver Anodized  
Material: Aluminum

CTS - ACC-PLATE

Mortise Lock



Narrow style lock body for  
aluminum door with latch and  
double throw dead bolt

CML - 30 x 85mm

Dead Bolt

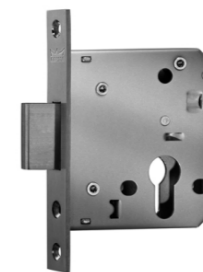

Closed body dead bolt for  
aluminum door/ wooden double  
throw dead bolt

CML - 50mm

Overhead Door Closer



Pelmet Arm with hold open  
Door Weight: Up to 60Kgs  
Finish: Silver

CTS - 02

Mortise Handle



Finish: Satin Finish  
Material: SS

CMHL - 1910

Bottom Lock



Finish: Satin Finish  
Material: SS

CPF - 03

Pull Handle



Size: 25mm x 450mm  
Finish: Satin Finish  
Material: SS

CPHL - 2518

Panic Bar



Push Type, Suitable for Solid Door  
Width: 800mm - 1200mm  
Finish: Silver

CPB - 900/ 1200

Sliding Roller

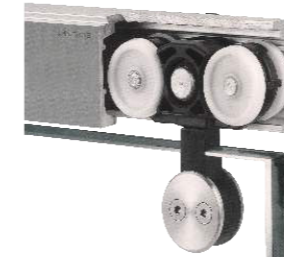

Roller for glass and solid door  
Door Weight: Up to 40Kgs

CSR - 01

Sliding Track

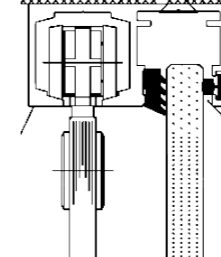

Length: 3000mm  
Finish: Silver Anodized  
Material: Aluminum

CST - 01

Cylinder



One side key, one side knob with  
Ultra key brass 60mm

CCNK - 70

Cocealed Door Closer



With hold unit  
Door Weight: Up to 60Kgs  
Finish: Silver

CTS - 01



## ALL PRODUCT OFFERINGS

### ALUMINUM

System Doors & Windows  
Office Cabinets & Partitions  
Store Fronts & Glazings  
Curtain Wall & Structural Glazings  
AL. Composite Cladding

### GLASS

Frameless Shower Cubicles  
Spider Glazing  
Showroom Fronts  
Sky Lights  
Residence Glasses

### STRUCTURAL

Skylights & Domes (Glass, Polycarbonate)  
Glass Coverages with Single Rope System  
Tensile Structures  
Canopies (M.S., Glass, S.S.)  
Glass Floors (Walkable)  
Glass Railings  
Pergolas (M.S., Aluminum, S.S.)  
Fins & Other Elevational Structures (Aluminum, M.S., S.S.)

### UPVC

Doors & Windows



SISTER CONCERNS



ASSOCIATED WITH





---

Team Classic

Classic Tower, 267, New Atish Market,

Opp. Sunny Mart, Gopalpura Bypass, Jaipur - 302020

E: [admin@teamclassic.in](mailto:admin@teamclassic.in) | [sales@teamclassic.in](mailto:sales@teamclassic.in)

T: 0141 - 2394671, +91 9784010168

