

CLASSIQUE[®]
GLAZINGS & CLADDINGS
FRAMELESS GLASSES

[®]
Window planet
Engineered System Windows & Doors
aluminium-upvc
Better Living...

Team Classic



Window planet

Engineered Windows & Doors
aluminium - UPVC

Better living....



24+ years
of experience



Capacity To serve
from 1 to 1000+ windows



Touch & Feel
Experience Centre



Consultation
Facility



Customised Engineering
Solutions



Window planet

Engineered System Windows & Doors
aluminium-upvc
Better Living...

SERIES

Mercury: Budget Eurogroove (20mm-SLD)

Mercury: Standard Eurogroove (22 mm-SLD)

Venus: Domal Eurogroove (27mm-SLD)

**Venus: Special Eurogroove, Open Track Series
(25mm- SLD)**

**Earth: Special Eurogroove, Open track series
(29mm-SLD)**

Jupiter: Bold Eurogroove (37mm-SLD)

Mars: Italian Slim Eurogroove (35mm-SLD)

**Planet Nine: SlimLine Series (HOPO- Light &
Heavy)**

Planet Nine: SlimLine Series (imported)

Mercury: Budget Eurogroove (28mm-CMT)

Mercury: Standard Eurogroove (40 mm-CMT)

Venus: Domal eurogroove (50mm-CMT)

Pluto: Tilt and Turn Series (CMT)

Neptune: Sliding Folding Series (S&F)

Saturn: Italian Eurogroove (54mm-CMT)

Uranus: Italian Eurogroove (70mm-CMT)

Planet Nine: Revolving Window

Mercury: Budget Eurogroove (20 mm)

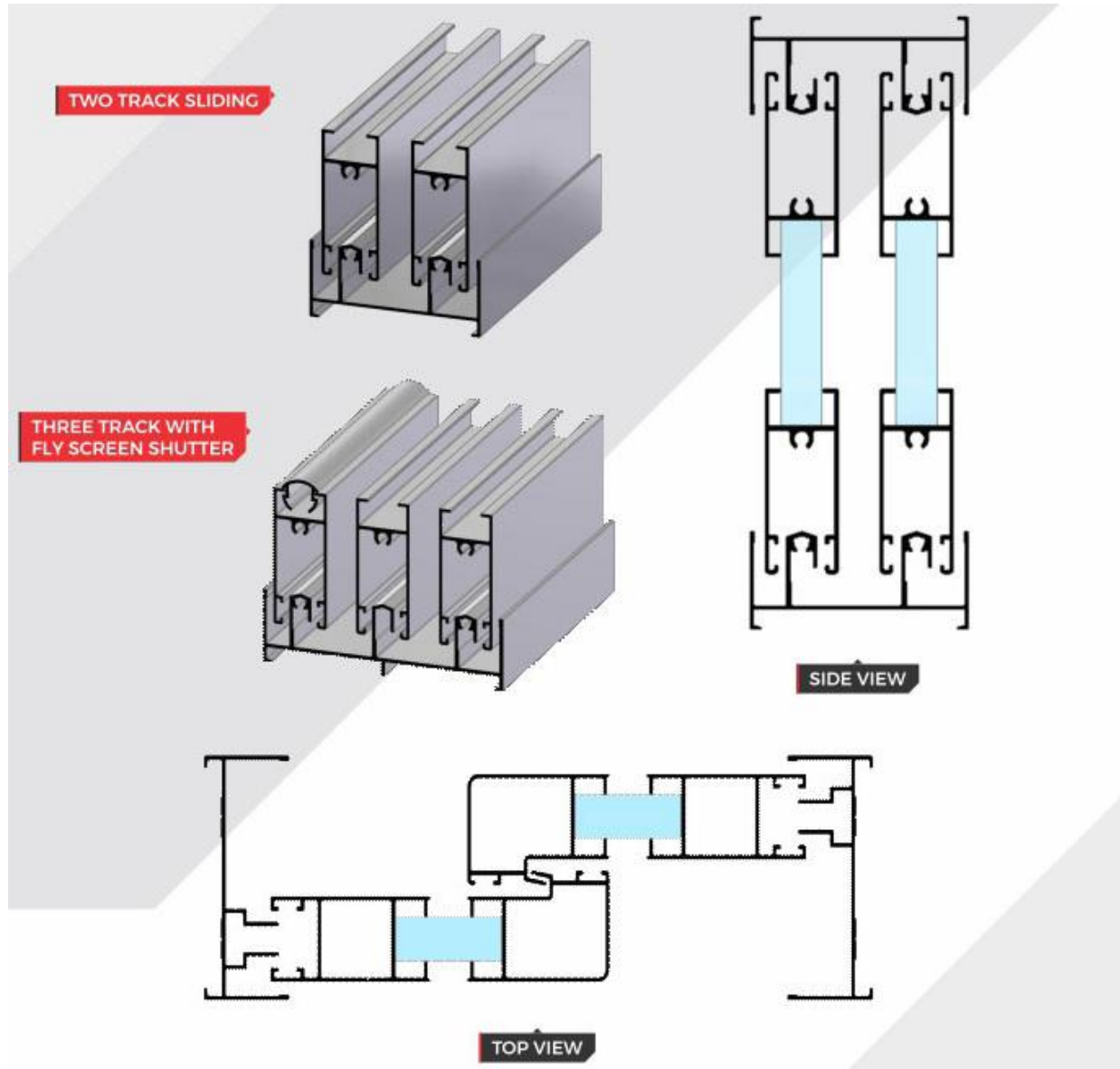

Key Features

- Sleek Design
- Hardware is designed to be compatible with the aluminium sections
- Light weight sections
- Automatic locks are available
- Maximum single shutter dimensions 900mm x 1350mm
- Maximum Glass Thickness - 5mm/6mm Available in
 - 2track, 3track
 - Fly mesh can be installed
 - Suitable for commercial places like industrial shades, warehouses etc.

Available in many Colors and Finishes:

Powder Coating, Anodizing, PVDF Coating, Wood Finish

Mercury: Standard Eurogroove (22 mm)

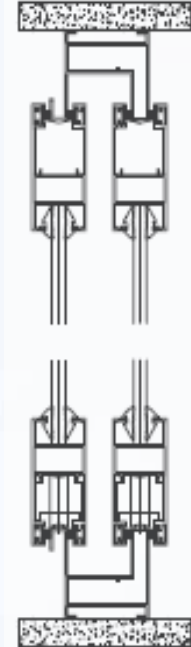

Key Features

- Sleek Design
- Hardware is designed to be compatible with the aluminium sections
- Light weight sections
- Both manual and automatic locks are available
- Maximum single shutter dimensions 900mm x 1800mm
- Maximum Glass Thickness - 5mm/6mm
- Available in 2track & 3track frames
- Fly mesh can be installed
- Suitable for commercial places like offices, institutes etc

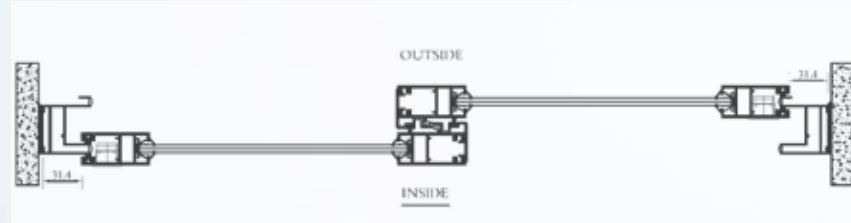

Available in many Colors and Finishes:

Powder Coating, Anodizing, PVDF Coating, Wood Finish

Mercury: Standard Eurogroove (22 mm) Combination Window

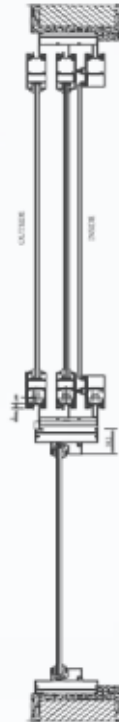

Key Features

- Combination Of Sliding & Fixed Window
- Available in 2track & 3track
- Maximum single shutter dimensions - 900mmx1800mm
- Maximum Glass Thickness - 5mm/6mm
- Fly mesh can be installed
- Special drainage for better outflow of water during monsoons
- Suitable for commercial places like offices, institutes etc.

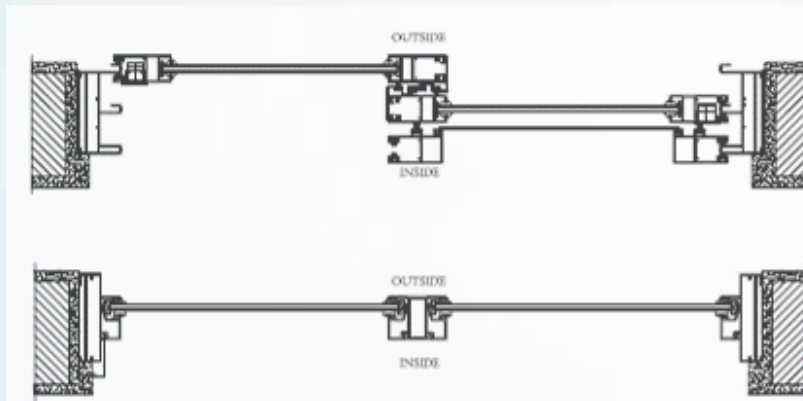

Available in many Colors and Finishes:

Powder Coating, Anodizing, PVDF Coating, Wood Finish

Venus: Domal Eurogroove (27mm)

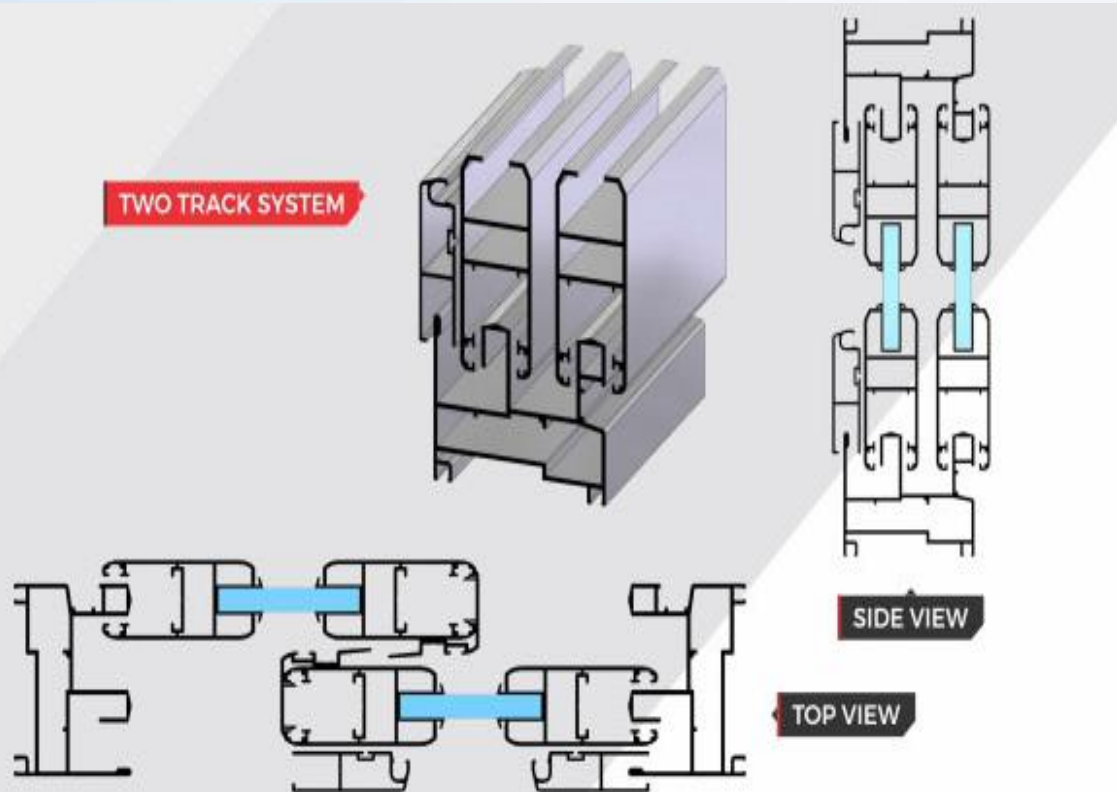

Key Features

- Available in 2track, 3track & 4track frames
- Sleek Design
- Hardware is designed to be compatible with the aluminium sections
- Fly mesh can be installed
- Light weight sections
- Both manual and automatic locks are available
- Maximum Single shutter size 900mm x 2100mm, DGU glass profile available
- Maximum glass thickness of 20mm
- Integration of wiremesh in same glass shutter possible

Available in many Colors and Finishes:

Powder Coating, Anodizing, PVDF Coating, Wood Finish

Venus: Domal Eurogroove (27mm) Slim Type



Key Features

- Available in 2track & 3track track frames
- Option of single or double insulated glass
- Anti-capillary polypropylene pads maximum single shutter size upto 1200mm x 2200mm
- Maximum glass thickness of 20 mm
- Multi-point lock available
- KPA D.G.Handle Shutter available
- Integration of Fly-mesh can be easily done in the same glass shutter
- Slim Interlock Reinforcement

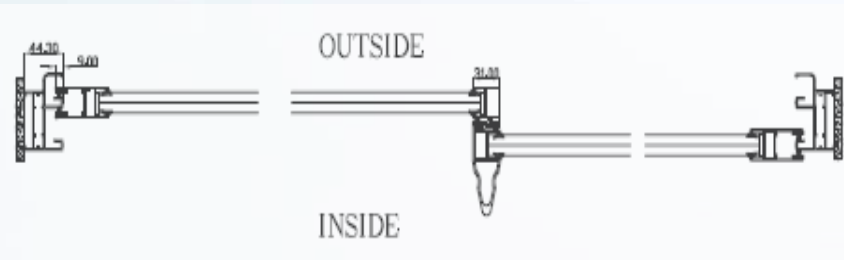

Available in many Colors and Finishes:

Powder Coating, Anodizing, PVDF Coating, Wood Finish

Venus: Domal Eurogroove (27mm) Combination Window

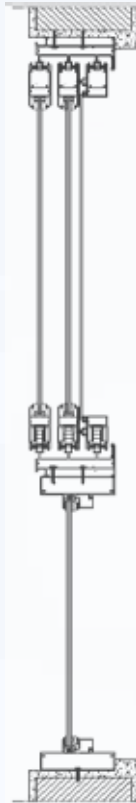

Key Features

- Combination Of Sliding & Fixed Window
- Available in 2track & 3track
- Maximum single shutter size - 1200mm x 2200mm
- Maximum Glass Thickness – 20mm
- Shutter of Single & Double Glass available
- Fly mesh can be installed
- Single Point & Multi Point locking available
- Sleeker & Sturdier
- Handle section with reinforcement to withstand wind loads in high rises
- Special drainage for better outflow of water during monsoons

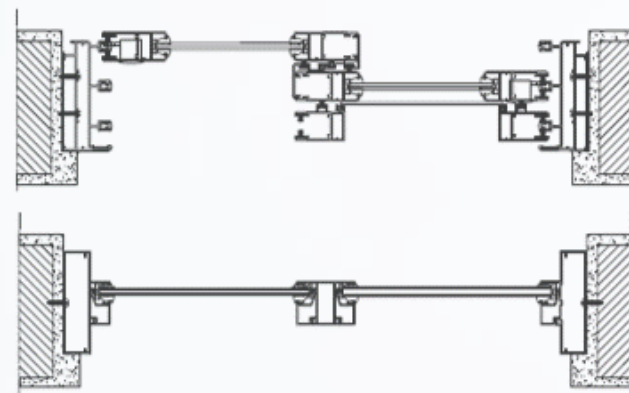

Available in many Colors and Finishes:

Powder Coating, Anodizing, PVDF Coating, Wood Finish

Venus: Special Eurogroove, Open track (25mm)



TWO TRACK SYSTEM



THREE TRACK WITH FLY SCREEN SHUTTER

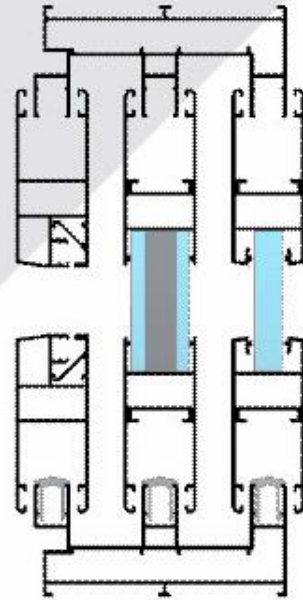
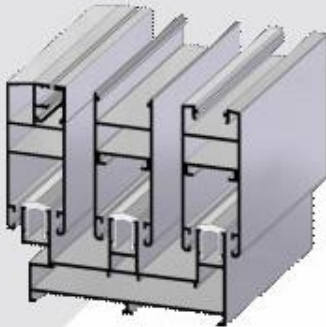

SIDE VIEW

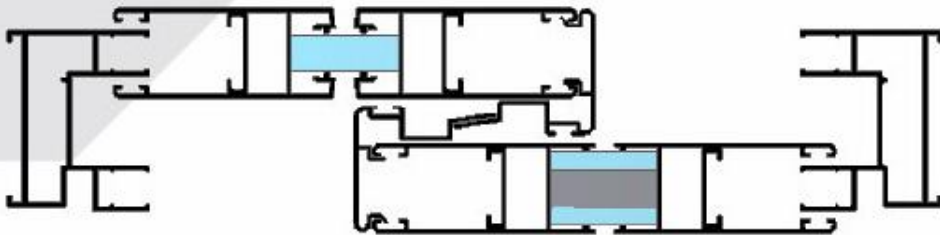

TOP VIEW

Key Features

- Available in – 2track & 3track frames
- Option of single or double insulated glass Shutter
- Single shutter size upto 900mm x 2200 mm
- Maximum glass thickness of 20mm
- Multi-point lock available
- Integration of Fly - mesh can be easily done in the same glass shutter
- REINFORCED interlock available - can go upto 1.5 KPA

Available in many Colors and Finishes:

Powder Coating, Anodizing, PVDF Coating, Wood Finish

Earth: Special Eurogroove, Open track (29mm)



TWO TRACK WITH SLIM INTERLOCK SECTION

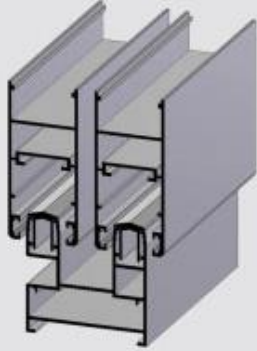

THREE TRACK WITH FLY SCREEN SHUTTER

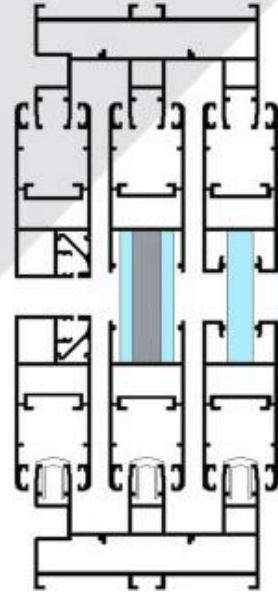
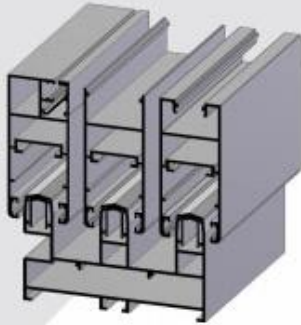

SIDE VIEW

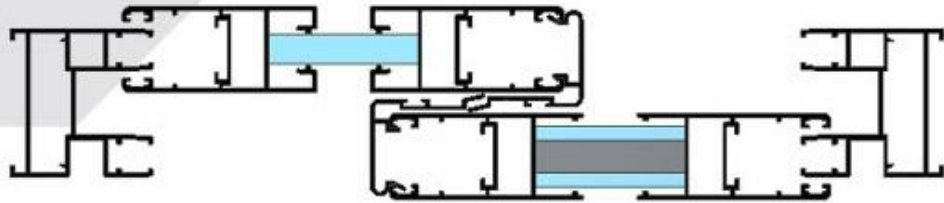

TOP VIEW

Key Features

- Available in – 2track, 3track, and 4track frames
- Option of single or double insulated glass Shutter
- Maximum Single shutter size upto 1500mm x 2750mm
- Maximum glass thickness of 22mm
- Multi-point lock available
- Integration of Fly - mesh can be easily done in the same glass shutter
- Reinforcement Interlock - can go upto 1.5 KPA

Available in many Colors and Finishes:

Powder Coating, Anodizing, PVDF Coating, Wood Finish

Earth: Special Eurogroove, Open track (29mm) SlimType



TWO TRACK WITH SLIM INTERLOCK SECTION

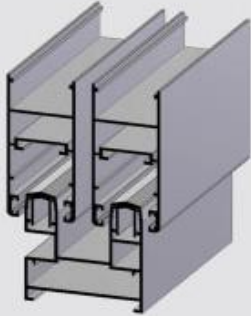

THREE TRACK WITH FLY SCREEN SHUTTER

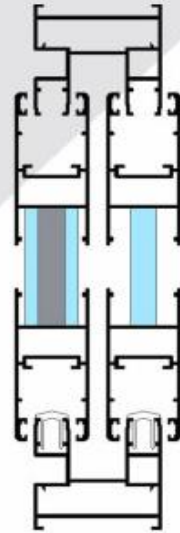
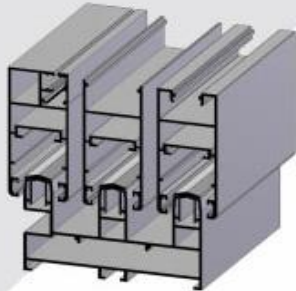

SIDE VIEW

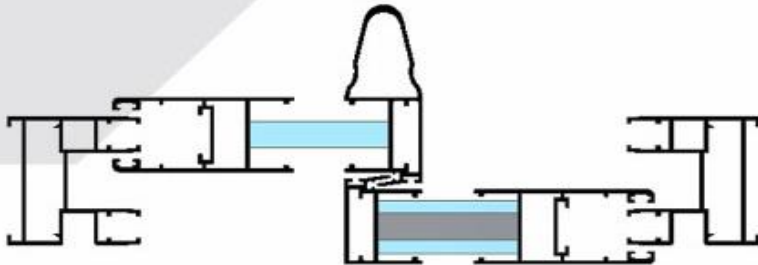

TOP VIEW

Key Features

- Available in – 2track, 3track, and 4track frames
- Option of single or double insulated glass
- Maximum Single Shutter size upto 1500mm x 3000 mm
- Maximum glass thickness of 24 mm
- Multi-point lock available
- Integration of Fly - mesh can be easily done in the same glass shutter
- Slim Interlock Reinforcement - can go upto 1.5 KPA

Available in many Colors and Finishes:

Powder Coating, Anodizing, PVDF Coating, Wood Finish

Jupiter: Bold Eurogroove (37mm)

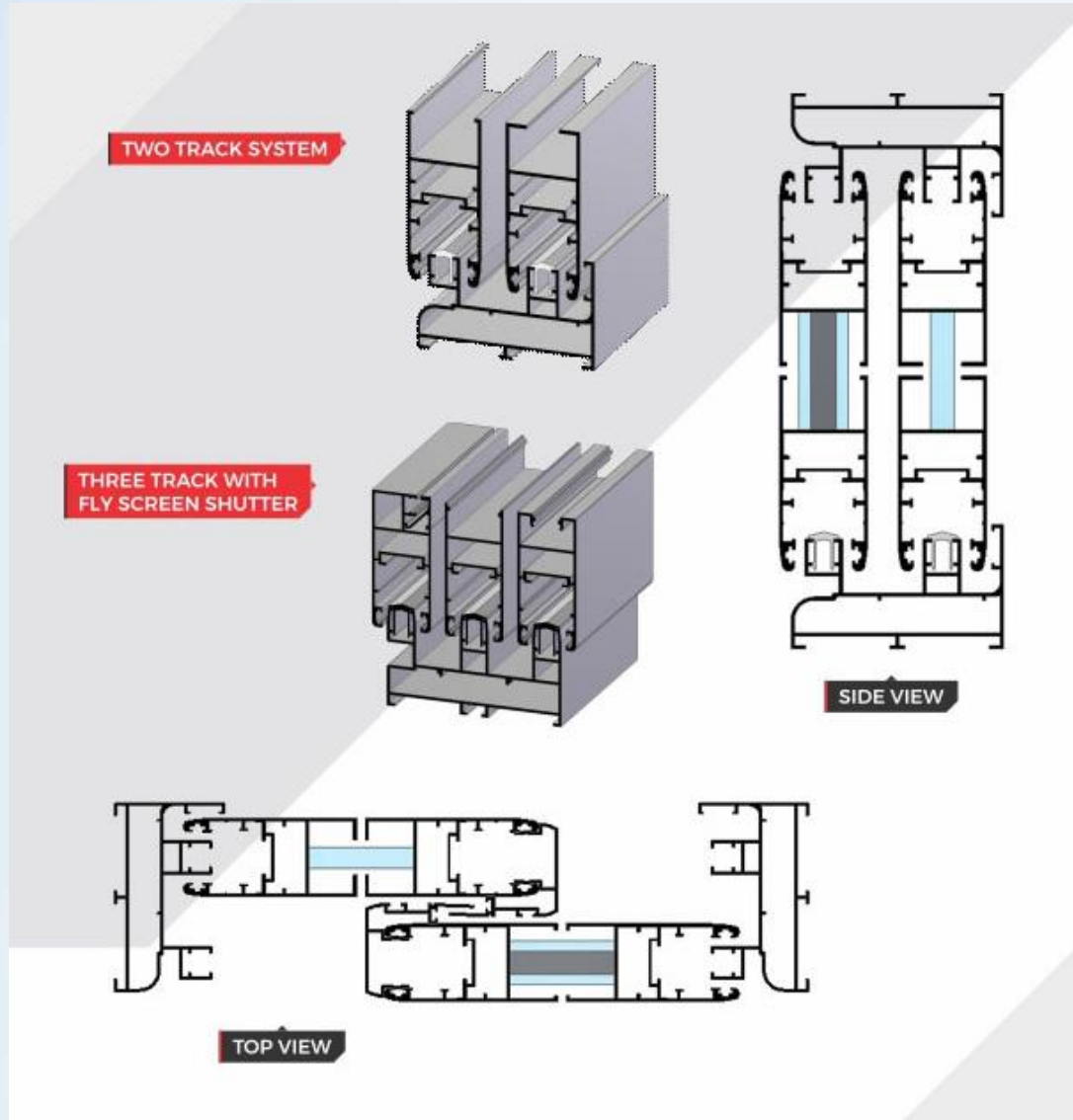

Key Features

- Available in – 2track & 3 track frames
- Option of single or double insulated glass
- Maximum Single Shutter size upto 1500mm x 3300 mm
- Maximum glass thickness of 28mm
- Multi-point lock available
- Integration of Fly - mesh can be easily done in the same glass shutter
- Reinforcement Interlock can go upto 1.5 KPA

Available in many Colors and Finishes:

Powder Coating, Anodizing, PVDF Coating, Wood Finish

Jupiter: Bold Eurogroove (37mm) Slim Type

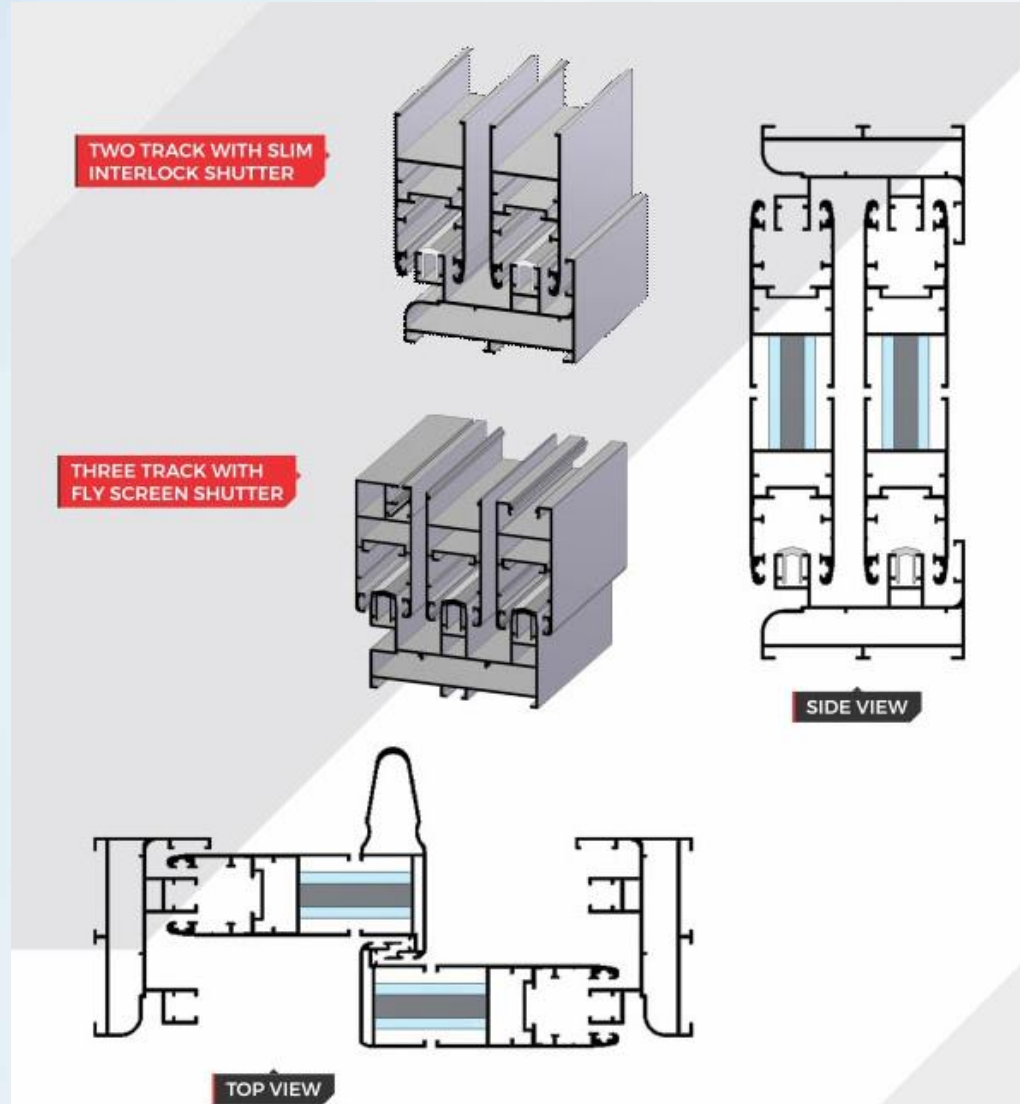

Key Features

- Available in – 2track & 3track frames
- Option of single or double insulated glass
- Shutter size upto 1500mm x 3300 mm
- Maximum glass thickness of 28mm
- Multi-point lock available
- KPA D.G.Handle Shutter available
- Integration of Fly - mesh can be easily done in the same glass shutter
- Slim Interlock Reinforcement - can go upto 1.5 KPA

Available in many Colors and Finishes:

Powder Coating, Anodizing, PVDF Coating, Wood Finish

Jupiter: Bold Eurogroove (37mm) Combination Window

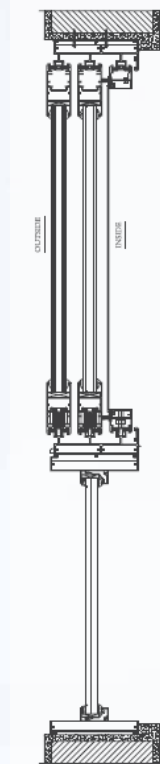

Key Features

- Available in 2track & 3track frames
- Maximum shutter dimensions - 1500x3300mm
- Maximum Glass Thickness - 28mm
- Shutter of Single & Double Glass available
- Slim Interlock Reinforcement - It can go up to 1.5KPA
- Flymesh can be installed
- Single Point & Multi Point locking available
- Sleeker & Sturdier
- Anodized add-on rail to protect from damages caused by regular operations
- Handle section with reinforcement to withstand wind loads in high rises
- Special drainage for better outflow of water during monsoons

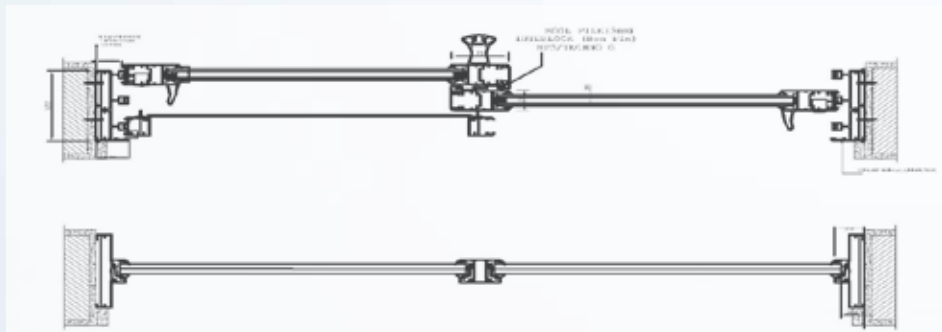

Available in many Colors and Finishes:

Powder Coating, Anodizing, PVDF Coating, Wood Finish

Mars: Italian slim Eurogroove (SL35)

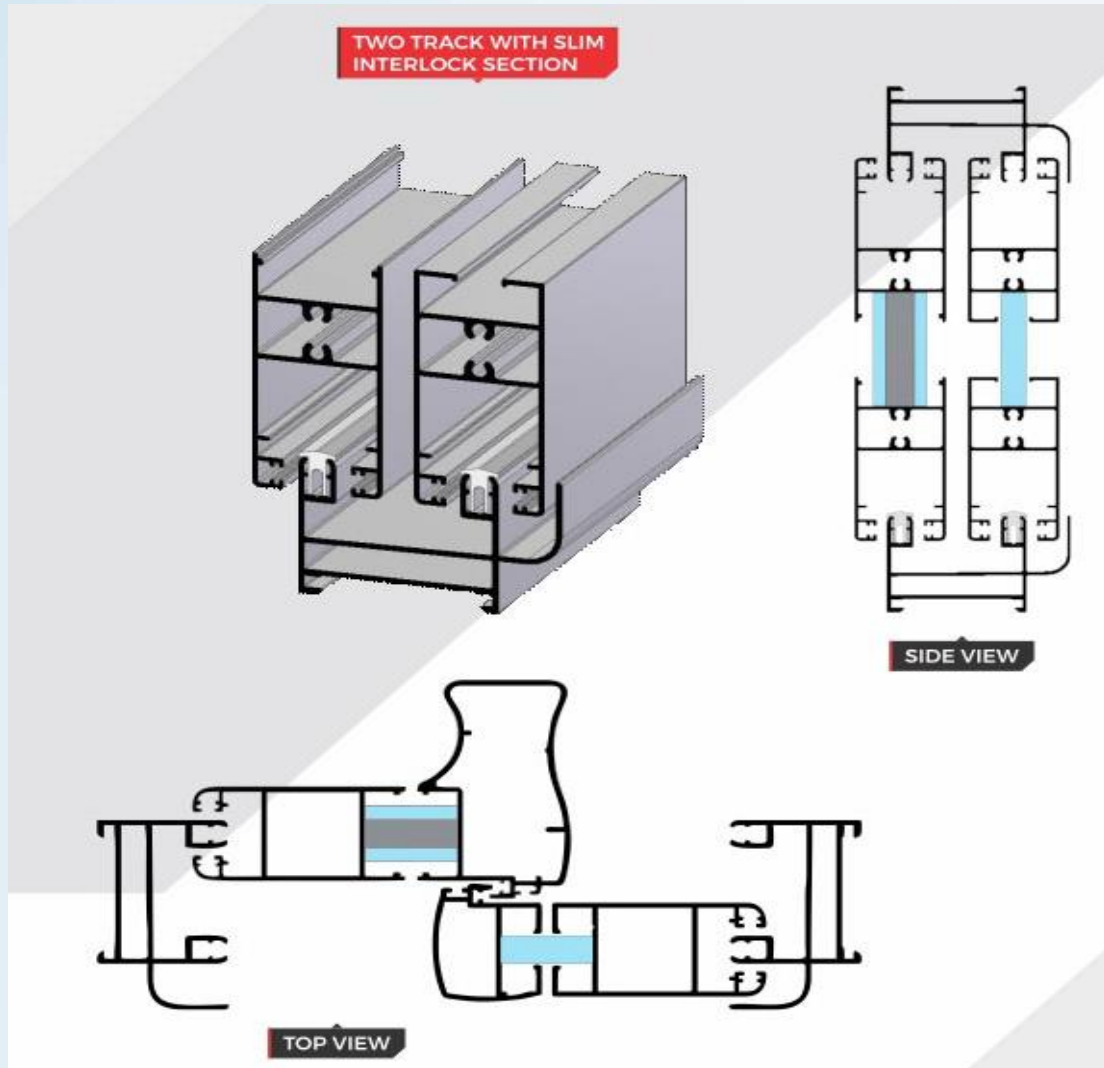

Key Features

- Available in 2track & 3track
- Maximum shutter dimensions - 1500x3000mm
- Maximum Glass Thickness - 28mm
- Shutter of Single & Double Glass available
- Slim Interlock Reinforcement - It can go up to 1.5KPA
- Flymesh can be installed
- Single Point & Multi Point locking available
- Sleeker & Sturdier
- Anodized add-on rail to protect from damages caused by regular operations
- Handle section with reinforcement to withstand wind load of high rises
- Special drainage for better outflow of water during monsoons

Available in many Colors and Finishes:

Powder Coating, Anodizing, PVDF Coating, Wood Finish

Mercury: Standard Eurogroove (40 mm) for Windows

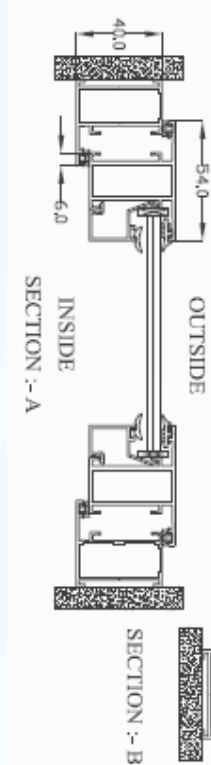

Key Features

- Shutter size upto 800mm x 1600mm
- Options for single/double shutter and combinations of Openable and Fixed possible
- Profiles compatible for Euro Groove Hardware
- Hair line corner joints possible with the help of spring loaded corner cleat
- Two point locking available
- Bigger sections for transom and bottom cill is also available
- Possibility to fit Mortise lock with cylinder and spring loaded handle for doors
- European make Special butt hinges for higher load carrying capacity

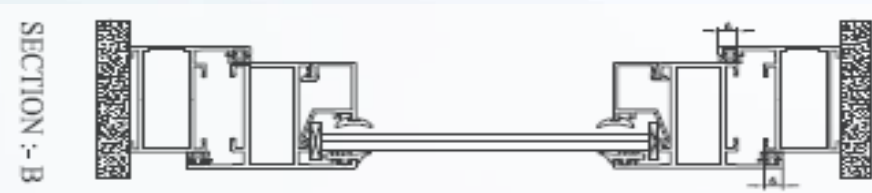

Available in many Colors and Finishes:

Powder Coating, Anodizing, PVDF Coating, Wood Finish

Mercury: Standard Eurogroove (40 mm) for Doors



Key Features

- Shutter size upto 900mm x 2200mm
- Options for single/double shutter and combinations of openable and fixed possible
- Profiles compatible for Euro Groove Hardware
- Hair line corner joints possible with the help of spring loaded corner cleat
- Two-point locking available
- Possibility to fit Mortise lock with cylinder and spring loaded handle for doors
- European make special butt hinges for higher load carrying capacity



Available in many Colors and Finishes:

Powder Coating, Anodizing, PVDF Coating, Wood Finish

Venus: Domal Eurogroove (50mm) for Windows

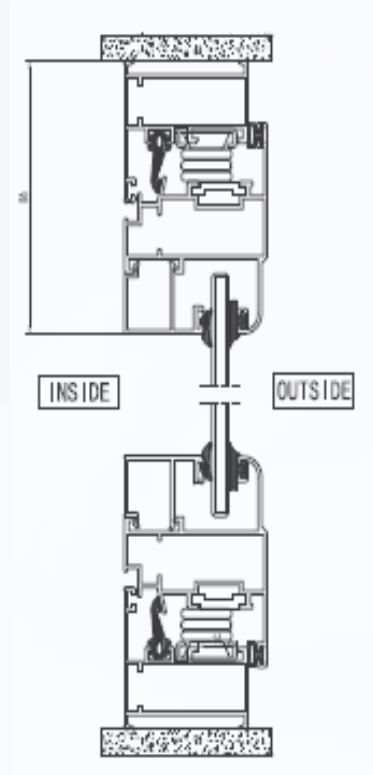

Key Features

- System Window Series based on European Groove (EG) Design
- Options for single/double shutter and combinations of Openable and Fixed possible
- Shutter Size upto 900mm x 2000mm
- Glazing Options - Single Glass (6mm and 8mm)
- Glazing Options - Double Glass (22mm and 40mm)
- Multi-point locking available
- Windows suitable for Wind Load upto 1.6 KPA

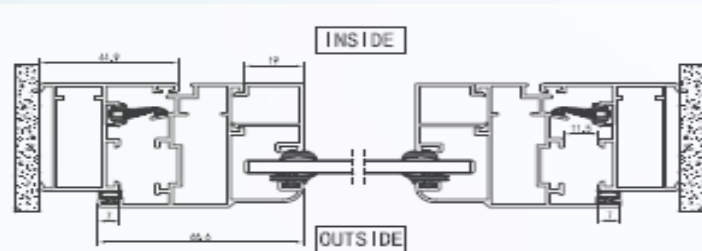

Available in many Colors and Finishes:

Powder Coating, Anodizing, PVDF Coating, Wood Finish

Venus: Domal Eurogroove (50mm) for Doors

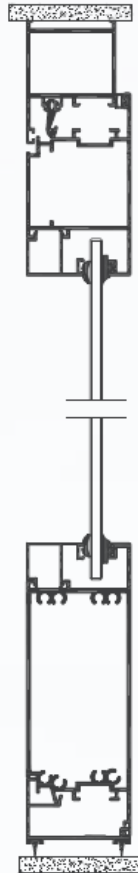

Key Features

- Options for single/double shutter
- Options for single/double glass
- Two-point locking available
- Possibility to fit Mortise lock with cylinder and spring loaded handle for doors
- Shutter Size upto 900mm x 3000mm
- Profiles compatible for EUROgroove hardware
- Special heavy and light duty butt hinges for carrying capacity
- Maximum Glass Size 24mm

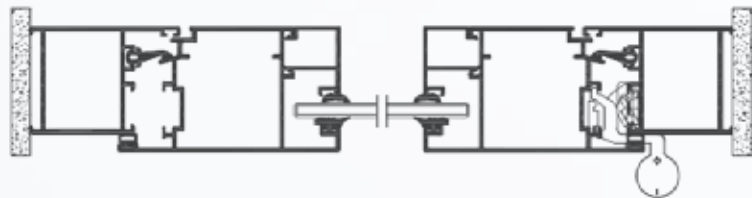

Available in many Colors and Finishes:

Powder Coating, Anodizing, PVDF Coating, Wood Finish

Venus: Domal Eurogroove (50mm) Parallel opening window

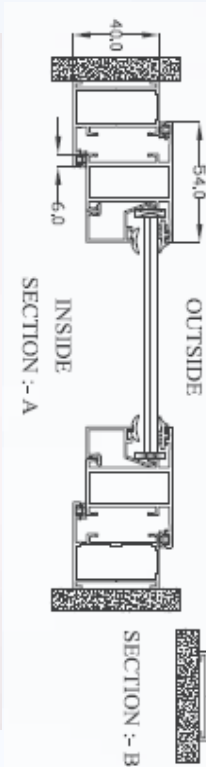

Key Features

- Suitable for ventilation
- Provides safety - Does not open more than 6 to 8 inches
- Maximum Size - 2100mm x 1500mm
- Glazing Thickness - 6mm, 8mm, 22mm and 24mm
- Picture Window
- Load carrying capacity upto 100 Kgs

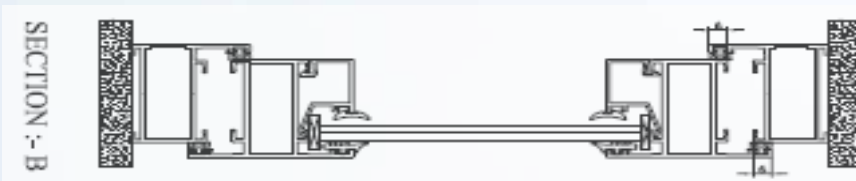

Available in many Colors and Finishes:

Powder Coating, Anodizing, PVDF Coating, Wood Finish

Pluto: Tilt and Turn

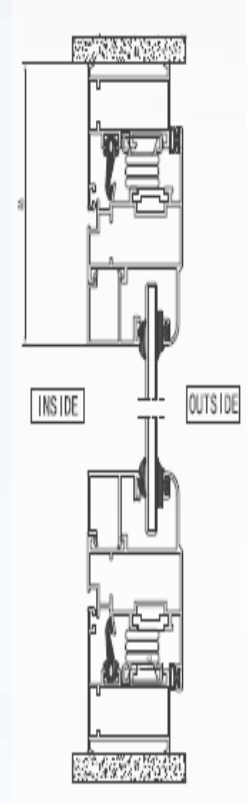

Key Features

- Shutter size upto 760mm x 1500mm
- Glazing Options - Single Glass (6mm and 8mm)
- Glazing Options - Double Glass (22mm and 24mm)
- Three - Window operations in one; tilts and turns with a single lever
- Easy to reach from inside for cleaning and maintenance
- Added security can be used as a fire or smoke escape window
- Draht - free ventilation, used in conference rooms and duct areas

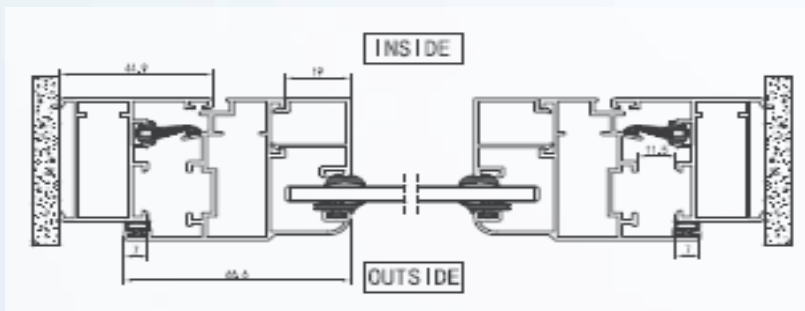

Available in many Colors and Finishes:

Powder Coating, Anodizing, PVDF Coating, Wood Finish

Neptune: Sliding Folding Series



Key Features

- Maximum Shutter Dimensions (SGU) - 800mm x 2700mm
- Maximum Shutter Dimensions (DGU) - 750mm x 2500mm
- Shutter combination available in odd numbers
- Glazing Options - 5mm - 18mm
- Multi-point lock available
- Inside and Outside Folding thus giving more open space
- 100% Opening to your verandas and gardens

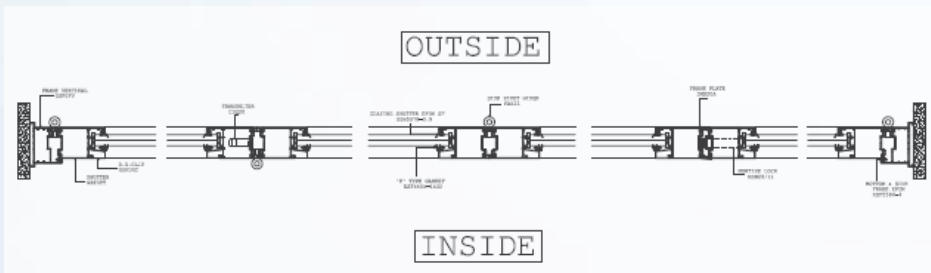

Available in many Colors and Finishes:

Powder Coating, Anodizing, PVDF Coating, Wood Finish

Director's Message

Since the last 2 decades, we have served the architectural market with complete honesty and transparency.

We are committed to total customer satisfaction by identifying their specific needs, offering them customised solutions and providing dependable after-sales services.

I therefore, seek continued patronage of our valued customers and cooperation of our employees who have contributed to the growth of the organization.

DUE TO CONFIDENTIALITY ISSUES WE HAVE NOT DISPLAYED ALL THE PHOTOS/CROSS SECTIONS & THIS CATALOGUE IS NOT A COMPLETE CATALOGUE. WE KEEP ON UPGRADING / ADDING NEW SERIES ATLEAST 1-2 IN EVERY QUARTER. WE DO CUSTOMISATION AS PER REQUIREMENTS WITH OUR EXPERTISE & FOCUSSED R&D.

KEEP CHARGED.....always.....

ASHISH - ANKUR KABRA

CLASSIQUE[®]
GLAZINGS & CLADDINGS
FRAMELESS GLASSES



Window planet
Engineered System Windows & Doors
aluminium-upvc
Better Living...



Team Classic

Classic Tower, 267, New Atish Market, Opp. Sunny Mart,
Gopalpura Bypass, Jaipur - 302020



www.teamclassic.in | www.windowplanet.in



admin@teamclassic.in | sales@teamclassic.in



0141 - 2394671, +91 9784010168

PRODUCT OFFERINGS

ALUMINIUM

System Doors & Windows
Office Cabinets & Partitions
Store Fronts & Glazings
Curtain Wall & Structural Glazings,
AL. Composite Cladding

GLASS

Frameless Shower Cubicles
Spider Glazing
Showroom Fronts
Sky Lights
Residence Glasses

UPVC

Doors & Windows

STRUCTURAL

Skylights & Domes (Glass, Polycarbonate)
Glass Coverages with Single Rope System
Tensile Structures
Canopies (M.S., Glass, S.S.)
Glass Floors (Walkable)
Fins & Other Elevational Structures (Aluminium, M.S., S.S.)
Glass Railings
Pergolas (M.S., Aluminium, S.S.)

NEW LAUNCHES

Vertical Sliding Windows
Aluminium Wardrobe Fronts
Smart Glass Films (Switchable)
Movable Aluminium Louvered Skylights
Movable (Sliding/ Openable) Glass Skylights
Movable Fabric Screen Pergolas/ Window Screens
Motorised/ Manual Blinds Within the Glass (IGU Blinds)
Breathing Windows (Even without opening the window)
Minimal Systems Sliding Windows (Single Sash upto 5 Mtrs Height)

